

Panasonic

PROFESSIONAL LED LIGHTING

CATALOGUE 2021



LIGHTING THE WAY TO A BETTER WORLD



Light does not only illuminate objects. It also dramatically enhances the atmosphere of living spaces as well as allows for the occupants to feel relaxed and at ease. LED lighting, in particular, offers greater energy savings along with higher colour rendering properties, opening up a new realm of possibilities.

For over 60 years, Panasonic has continued to advance lighting in terms of technology, quality and design methods for spaces. Panasonic now enjoys a proven track record as a trusted, first choice brand of lighting products in Japan.*

“Panasonic LED” will continue to achieve greater energy savings while enriching various living spaces and urban environments around the world.

Experience for yourself how our LED lighting products add value to any application.

*Panasonic survey in September 2014

Panasonic LED

MORE BEAUTY

Uniform bright light and distinct shadows provides maximum lighting quality to create living environments with more beauty.



MORE COMFORT

Optimal lighting solutions created with Panasonic Lighting design methods for spaces make everyday living more comfortable.

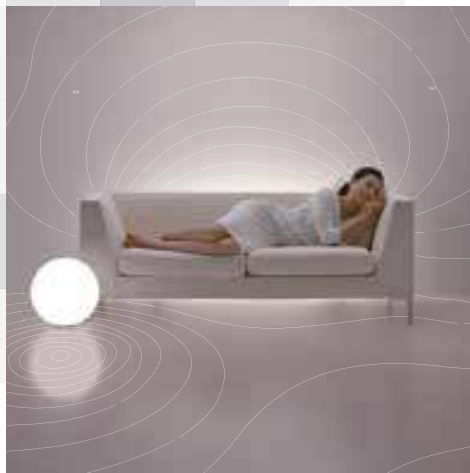

MORE RELIABILITY

Uncompromised quality following stringent internal safety standards along with international standards to ensure long-term reliability.



PANASONIC'S UNIQUE PROFESSIONAL ASSISTANCE

Panasonic Professional Lighting offers 3 core values;

Beauty, Comfort and Reliability

In addition to the 3 core values we also provide assistance through our light engineering support, technical tools and Panasonic unique Technologies.

We provide solutions that balance out customer's business success and environmental & social sustainability.

*Panasonic survey in September 2014



Planning and basic design

- Creating the lighting concept
- A sketched image of the proposal
- Collaboration with designers and architects



Design and implementation

- Light distribution plan
- Considering the human sense of brightness through Feu
- Verification by real CG



Testing and on-site validation

- Use various lamps to test contrast effects
- Experimentation through a mockup
- Examination of the appearance of the light distribution and colour



Validation after completion

- Confirmation and adjustment on site at time of delivery
- Validation of illumination and Feu after delivery
- Accumulation of know-how



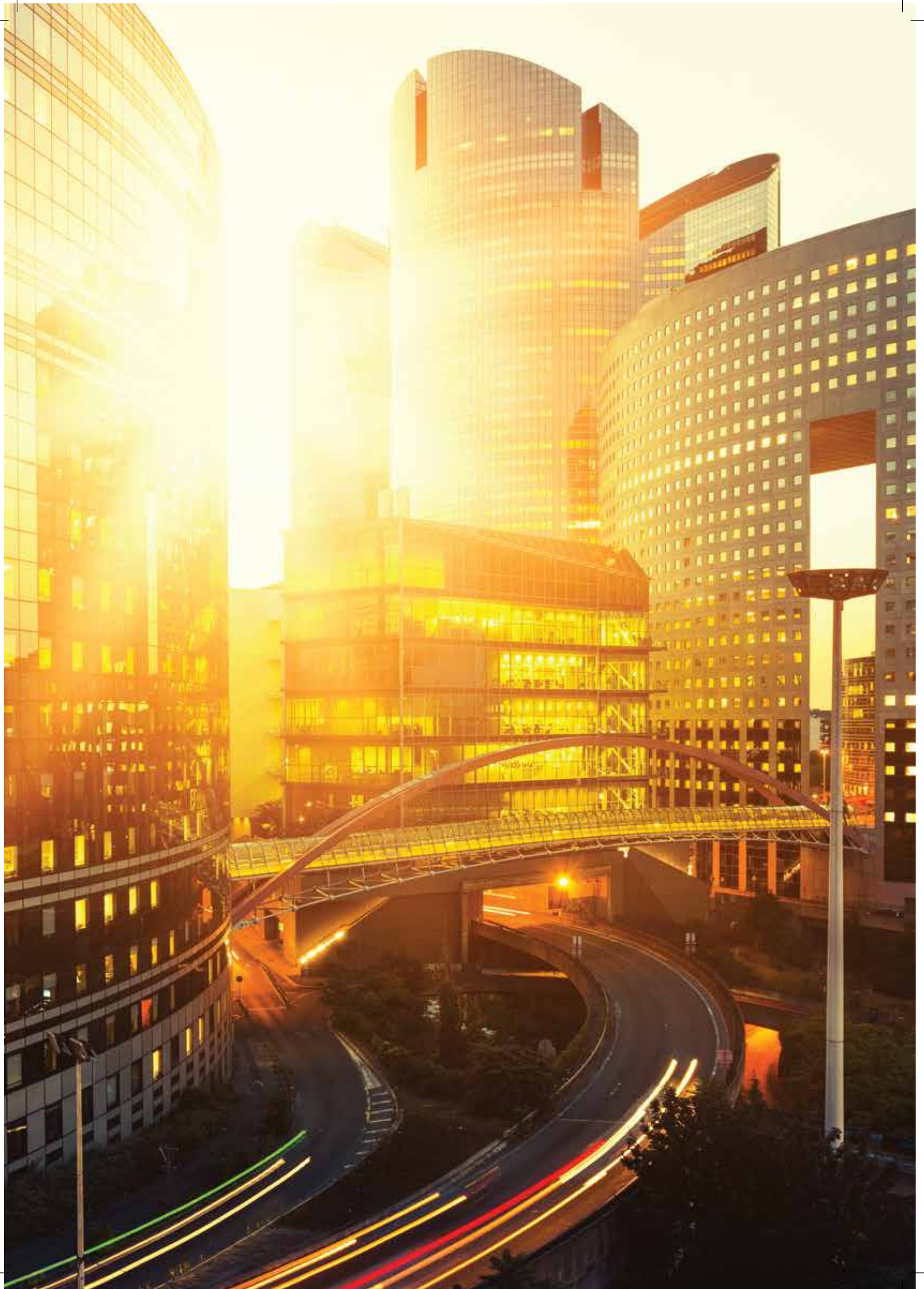

Contents

02 COMMERCIAL
LIGHTING



54 INDUSTRIAL
LIGHTING



90 STREET
LIGHTING



116 FLOOD
LIGHTING



136 LANDSCAPE
LIGHTING



152 OUR
PROJECTS



COMMERCIAL LIGHTING

A PERFECT BRIGHTER
WORKING ENVIRONMENT

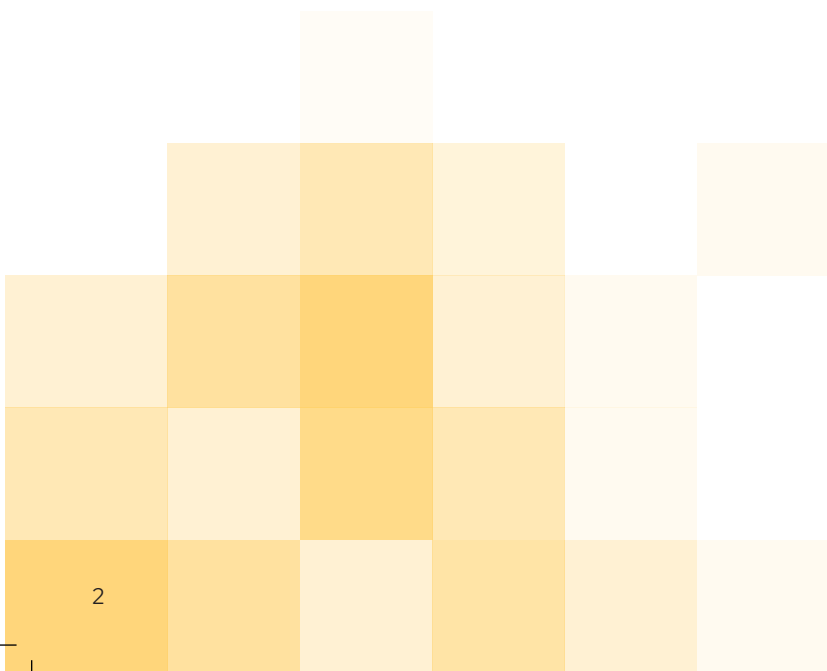

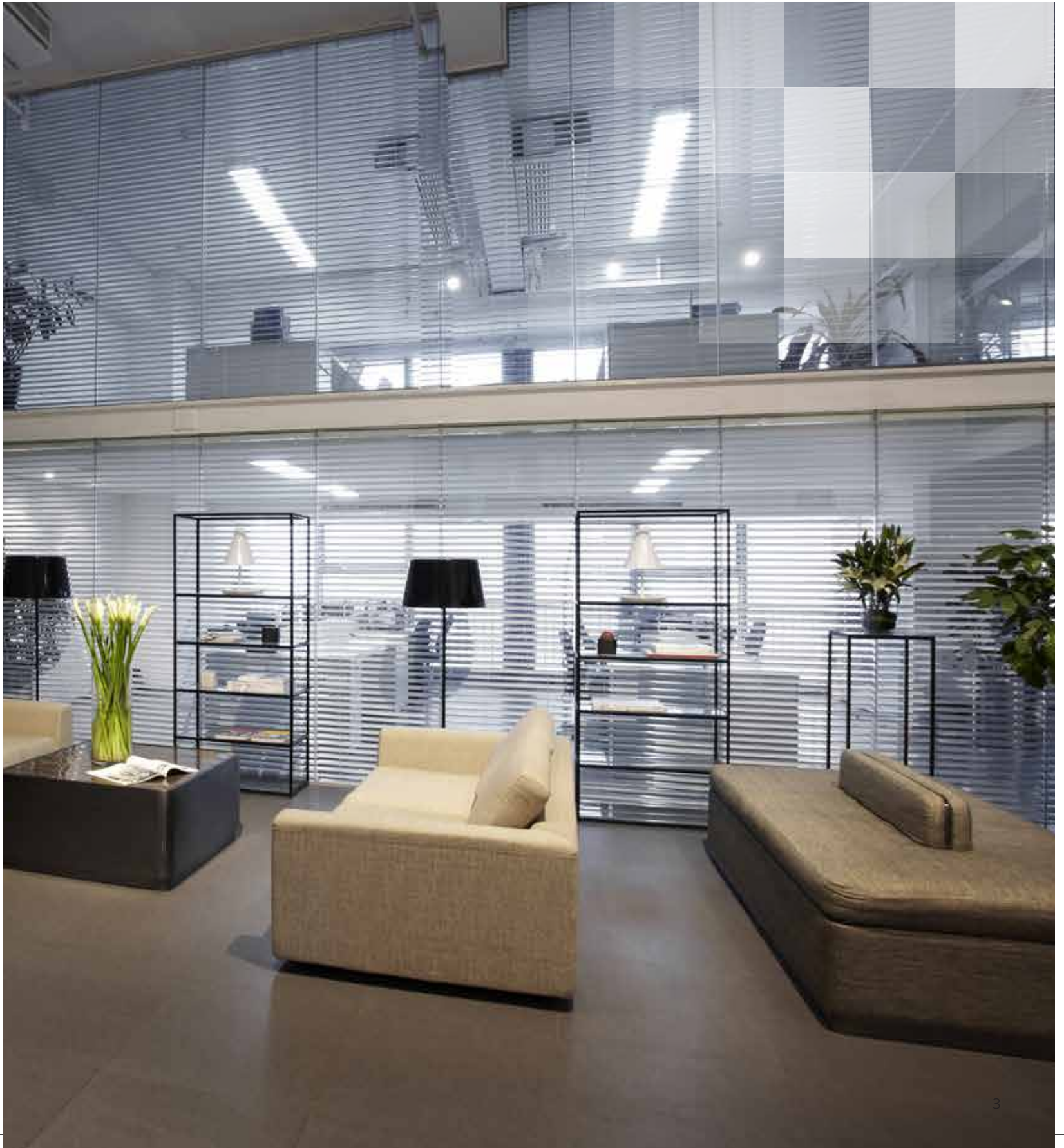



COMMERCIAL LIGHTING

Panasonic Indoor LED lighting provides a clear advantage over conventional lighting solutions and can free up significant time and resources for building owners, facility managers, and other stakeholders by requiring less maintenance time and materials. LEDs also benefit occupants of the building by providing higher quality lighting, and they help to drive down a building or facility's overhead costs.



2X2 BASE LIGHTING



Panasonic LED 2X2 Base lighting provides several benefits over conventional fluorescent recessed 2x2 lighting applications. Commercial, industrial, warehouse, office, and retail lighting applications can all find significant benefits with LED 2x2 lighting applications.

Panasonic LED 2x2 fixtures to provide significant performance improvements over fluorescent light fixtures. Panasonic 2x2 available in a wide range of CCTs, which provides end-users the ability to select a specific aesthetic look of a given space. Another benefit is the ability of the fixtures to dim; you are now able to change the operating conditions and adapt to the usage needs of individual rooms or spaces quickly.

LINEAR LIGHTING



Panasonic Linear lighting can completely transform the feel of a space and features significantly in contemporary architecture. Linear lighting designs are not restricted to single luminaires. Many suspended, recessed and surface light products can be linked together to create modular lighting designs. From subtle to standout designs, whether bold or slim lines, modular linear lighting can be used to create schemes to suit any space.

Surface linear lights are the ideal choice for low & vaulted ceilings and effectively use to enhance architectural features.

Recess linear lights can be used to create clean, invisible lines or shapes of light that blend seamlessly into the ceiling and wall surfaces of a space to become a part of its fabric.

Suspended linear lights provide a clean, continuous, linear profile of light, creating a contemporary feel for a range of applications and enhances architectural interest or complement the chosen space.

DOWN LIGHTS



Panasonic LED Downlights can be easily installed into a hollow space in the ceiling. They are brilliant energy-saving lighting solutions that are designed for a plethora of applications. Panasonic LED Downlights emit light in a downward direction with an accurate and narrow beam.

Recessed Downlights blend in with the ceiling, can be used with a decorative bezel to make a statement.

Surface Downlights are visible designs, can vary from simple to decorative to suit the architecture and design.

Pendant Downlights are chosen for aesthetic reasons to suit the surrounding design and vary greatly in style from modern and contemporary to traditional.

TECHZONE LIGHTING



TechZone® Ceiling Systems are based on 4"-, 6"- or 12"-wide technical zones for everything from air diffusers to sound systems. The result: a clean, monolithic look using standard ceiling panels and suspension systems, and a layout that accepts Beam 3 LED and Beam 6 LED luminaires, ensuring integrated lighting design.

HIGH SPEC BASELIGHT

SCANTO PLUS

20W/25W/30W/36W

Recess mounted LED luminaire equipped with CRCA powder coating housing, high transmittance diffuser for symmetric light distribution with non-integral energy efficient electronic driver.



High on Efficacy

20W & 25W - 130lm/W
30W & 36W - 120lm/W



Higher Energy Saving

Higher lumen package enables to meet the desired lux levels with reduced wattage



Wide Application

Wide lumen package selection suitable for retrofit, different installation height and optimisation of tile spacing in green field project



Safe & Reliable

THD<10%,
Inbuilt Surge Protection: 3kV
Class-I product



Non Integrated Isolated Driver

Protects the output /secondary side from any disturbance on the Input / Primary side ensuring safe operation



Higher Life

Life: 50,000 BH @ L70B50



Wide Operating Voltage / Rated Voltage

140-270V AC /
220-240V AC/50Hz



Operating Temperature

0°C to +45°C

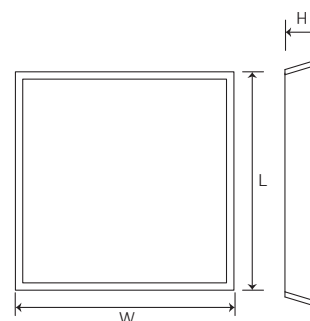

APPLICATIONS

Corporate Offices

Modern Workspaces

Banks

Software Centres

Hospitals



TECHNICAL SPECIFICATION

Product Code	System Wattage (W)	LxWxH (mm)	Cutout (mm)	THD	Colour Temp. (CCT)
PBLM21203	20W	595x595x70	575x575	≤ 10%	3000K
PBLM21204	20W	595x595x70	575x575	≤ 10%	4000K
PBLM21208	20W	595x595x70	575x575	≤ 10%	5700K
PBLM21253	25W	595x595x70	575x575	≤ 10%	3000K
PBLM21254	25W	595x595x70	575x575	≤ 10%	4000K
PBLM21258	25W	595x595x70	575x575	≤ 10%	5700K
PBLM21303	30W	595x595x70	575x575	≤ 10%	3000K
PBLM21304	30W	595x595x70	575x575	≤ 10%	4000K
PBLM21308	30W	595x595x70	575x575	≤ 10%	5700K
PBLM21363	36W	595x595x70	575x575	≤ 10%	3000K
PBLM21364	36W	595x595x70	575x575	≤ 10%	4000K
PBLM21368	36W	595x595x70	575x575	≤ 10%	5700K

UGR<19 BASELIGHT

SCANTO ADVANCE

30W

Recess mounted UGR < 19 LED luminaire equipped with CRCA powder coating housing with PS microprismatic diffuser for symmetric light distribution with non-integral energy efficient electronic driver.

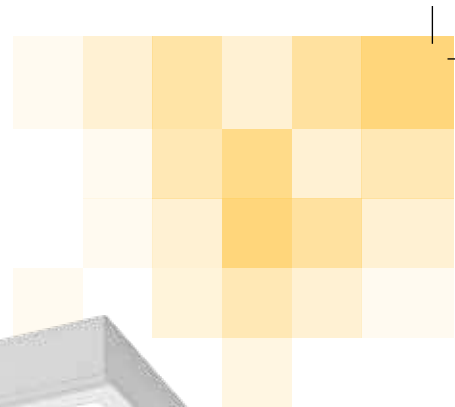

High on Efficacy

110lm/W



Higher Energy Saving

Higher lumen package enables to meet the desired lux levels with reduced wattage



Wide Application

Wide lumen package selection suitable for retrofit, different installation height and optimisation of tile spacing in green field project



Safe & Reliable

THD<10%,
Inbuilt Surge Protection: 3kV
Class-I product

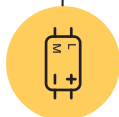

Non Integrated Isolated Driver

Protects the output /secondary side from any disturbance on the Input / Primary side ensuring safe operation



Higher Life

Life: 50,000 BH @ L70B50



Wide Operating Voltage / Rated Voltage

140-270V AC /
220-240V AC/50Hz



Operating Temperature

0°C to +45°C

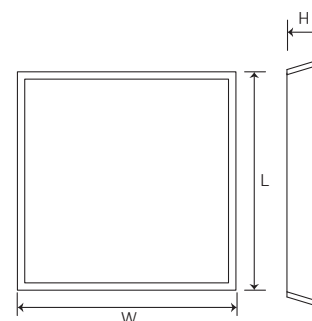

APPLICATIONS

Corporate Offices

Modern Workspaces

Banks

Software Centres

Hospitals



TECHNICAL SPECIFICATION

Product Code	System Wattage (W)	LxWxH (mm)	Cutout (mm)	THD	Colour Temp. (CCT)
PBLM23303	30W	595x595x70	575x575	≤ 10%	3000K
PBLM23304	30W	595x595x70	575x575	≤ 10%	4000K
PBLM23308	30W	595x595x70	575x575	≤ 10%	5700K

UGR<16 BASELIGHT

SCANTO ADVANCE

30W/36W

Recess mounted UGR < 16 LED luminaire equipped with CRCA powder coating housing with PS microprismatic diffuser for symmetric light distribution with non-integral energy efficient electronic driver.



High on Efficacy

110lm/W



Higher Energy Saving

Higher lumen package enables to meet the desired lux levels with reduced wattage



Wide Application

Wide lumen package selection suitable for retrofit, different installation height and optimisation of tile spacing in green field project



Safe & Reliable

THD<10%,
Inbuilt Surge Protection: 3kV
Class-I product



Non Integrated Isolated Driver

Protects the output /secondary side from any disturbance on the Input / Primary side ensuring safe operation



Higher Life

Life: 50,000 BH @ L70B50



Wide Operating Voltage / Rated Voltage

140-270V AC /
220-240V AC/50Hz



Operating Temperature

0°C to +45°C

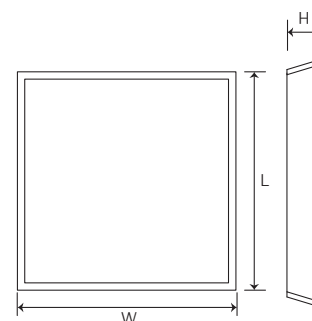

APPLICATIONS

Corporate Offices

Modern Workspaces

Banks

Software Centres

Hospitals



TECHNICAL SPECIFICATION

Product Code	System Wattage (W)	LxWxH (mm)	Cutout (mm)	THD	Colour Temp. (CCT)
PBLM24303	30W	595x595x35	575x575	≤ 10%	3000K
PBLM24304	30W	595x595x35	575x575	≤ 10%	4000K
PBLM24308	30W	595x595x35	575x575	≤ 10%	5700K
PBLM24363	36W	595x595x35	575x575	≤ 10%	3000K
PBLM24364	36W	595x595x35	575x575	≤ 10%	4000K
PBLM24368	36W	595x595x35	575x575	≤ 10%	5700K

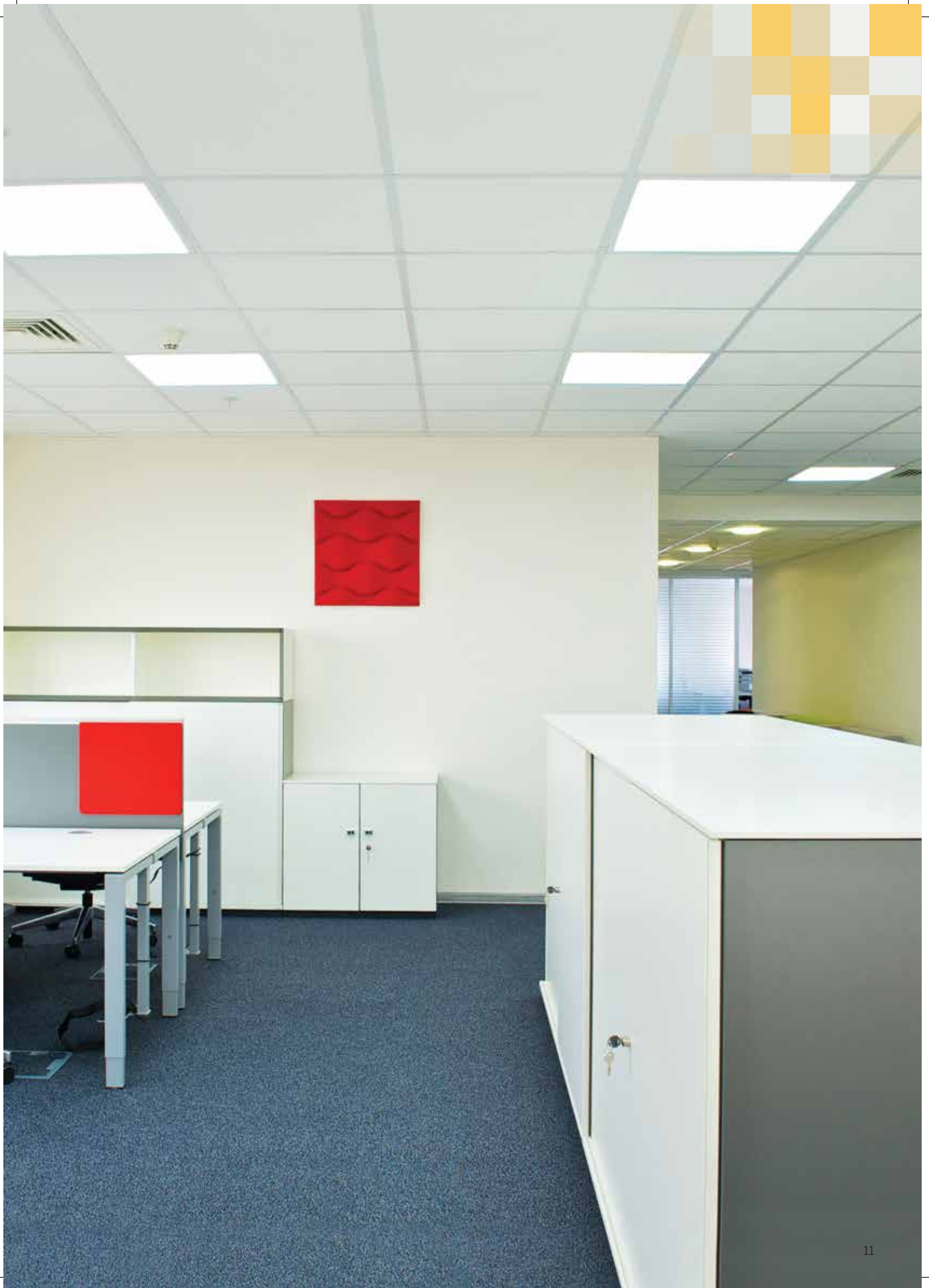

LOW DEPTH BASELIGHT

SCANTO

30W/36W

Recess mounted Low Depth LED luminaire equipped with CRCA powder coating housing, high transmittance diffuser for symmetric light distribution with non-integral energy efficient Isolated electronic driver.



High on Efficacy
Efficacy of 110lm/W



Low Depth
Suitable for ceiling wherein depth between True ceiling and False ceiling is constraint



Wide Operating Voltage / Rated Voltage
140-270V AC /
220-240V AC/50Hz



Safe & Reliable
THD<10%,
Inbuilt Surge Protection: 3kV
Class-I product



Non Integrated Isolated Driver
Protects the output / secondary side from any disturbance on the Input / Primary side ensuring safe operation



Higher Life
Life: 50,000 BH @ L70B50



Operating Temperature
0°C to +45°C

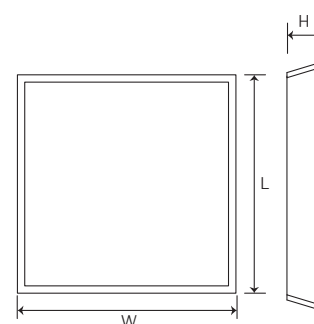

APPLICATIONS

- Corporate Offices
- Modern Workspaces
- Banks
- Software Centres
- Hospitals



TECHNICAL SPECIFICATION

Product Code	System Wattage (W)	LxWxH (mm)	Cutout (mm)	THD	Colour Temp. (CCT)
PBLM22303	30W	595x595x35	575x575	≤10%	3000K
PBLM22304	30W	595x595x35	575x575	≤10%	4000K
PBLM22308	30W	595x595x35	575x575	≤10%	5700K
PBLM22363	36W	595x595x35	575x575	≤10%	3000K
PBLM22364	36W	595x595x35	575x575	≤10%	4000K
PBLM22368	36W	595x595x35	575x575	≤10%	5700K

DECO BASELIGHT

SCANTO PRO
36W

The Deco 2X2 36W recess mounted baselight comprises of CRCA housing with drop down diffuser.

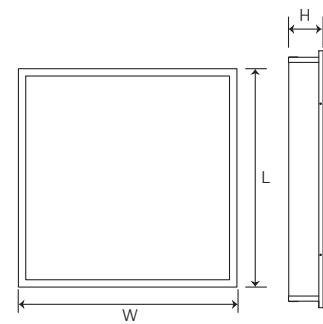

LG7 Compliant



Square & Octagon Shape
Drop down diffuser



Wide Operating Voltage / Rated Voltage
140-270V AC /
220-240V AC/50Hz



Safe & Reliable
THD<10%,
Inbuilt Surge Protection: 2kV
Class-I product



Non Integrated Isolated Driver
Protects the output / secondary side
from any disturbance on the Input /
Primary side ensuring safe operation



Higher Life
Life: 50,000 BH @ L70B50



Operating Temperature
0°C to +45°C

APPLICATIONS

- Corporate Offices
- Modern Workspaces
- Banks
- Software Centres
- Hospitals



TECHNICAL SPECIFICATION

Product Code	System Wattage (W)	LxWxH (mm)	Cutout (mm)	THD	Colour Temp. (CCT)
PBLM20363	36W	595x595x97	575x575	≤ 10%	3000K
PBLM20364	36W	595x595x97	575x575	≤ 10%	4000K
PBLM20368	36W	595x595x97	575x575	≤ 10%	5700K
PBLM19363	36W	595x595x97	575x575	≤ 10%	3000K
PBLM19364	36W	595x595x97	575x575	≤ 10%	4000K
PBLM19368	36W	595x595x97	575x575	≤ 10%	5700K





1X4 BASELIGHT SURFACE

SCANTO S

36W

The Scanto Surface 1X4 36W surface mounted baselight comprises of CRCA housing.

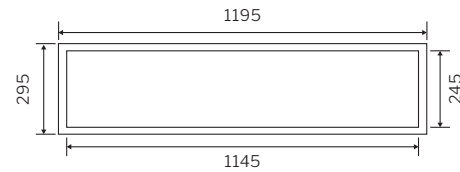

Mounting

Surface mounted



Wide Operating Voltage / Rated Voltage

140-270V AC /
220-240V AC/50Hz



Safe & Reliable

THD<10%,
Inbuilt Surge Protection: 2kV
Class-I product



Non Integrated Isolated Driver

Protects the output / secondary side
from any disturbance on the Input /
Primary side ensuring safe operation



Higher Life

Life: 50,000 BH @ L70B50



Operating Temperature

0°C to +45°C

APPLICATIONS

Corporate Offices

Modern Workspaces

Banks

Software Centres

Hospitals



TECHNICAL SPECIFICATION

Product Code	System Wattage (W)	LxWxH (mm)	Cutout (mm)	THD	Colour Temp. (CCT)
PBLM15363	36W - Surface	1195x295x70	—	≤ 10%	3000K
PBLM15364	36W - Surface	1195x295x70	—	≤ 10%	4000K
PBLM15368	36W - Surface	1195x295x70	—	≤ 10%	5700K



1X4 BASELIGHT RECESS

SCANTO R

36W

The Scanto Recess 1X4 36W recess mounted baselight comprises of CRCA housing .



Mounting

Recessed mounted



Wide Operating Voltage / Rated Voltage

140-270V AC /
220-240V AC/50Hz



Safe & Reliable

THD<10%,
Inbuilt Surge Protection: 2kV
Class-I product



Non Integrated Isolated Driver

Protects the output / secondary side
from any disturbance on the Input /
Primary side ensuring safe operation



Higher Life

Life: 50,000 BH @ L70B50



Operating Temperature

0°C to +45°C

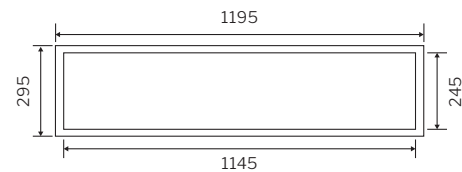

APPLICATIONS

Corporate Offices

Modern Workspaces

Banks

Software Centres

Hospitals



TECHNICAL SPECIFICATION

Product Code	System Wattage (W)	LxWxH (mm)	Cutout (mm)	THD	Colour Temp. (CCT)
PBLM16363	36W - Recess	1195x295x67	1145x245	≤ 10%	3000K
PBLM16364	36W - Recess	1195x295x67	1145x245	≤ 10%	4000K
PBLM16368	36W - Recess	1195x295x67	1145x245	≤ 10%	5700K

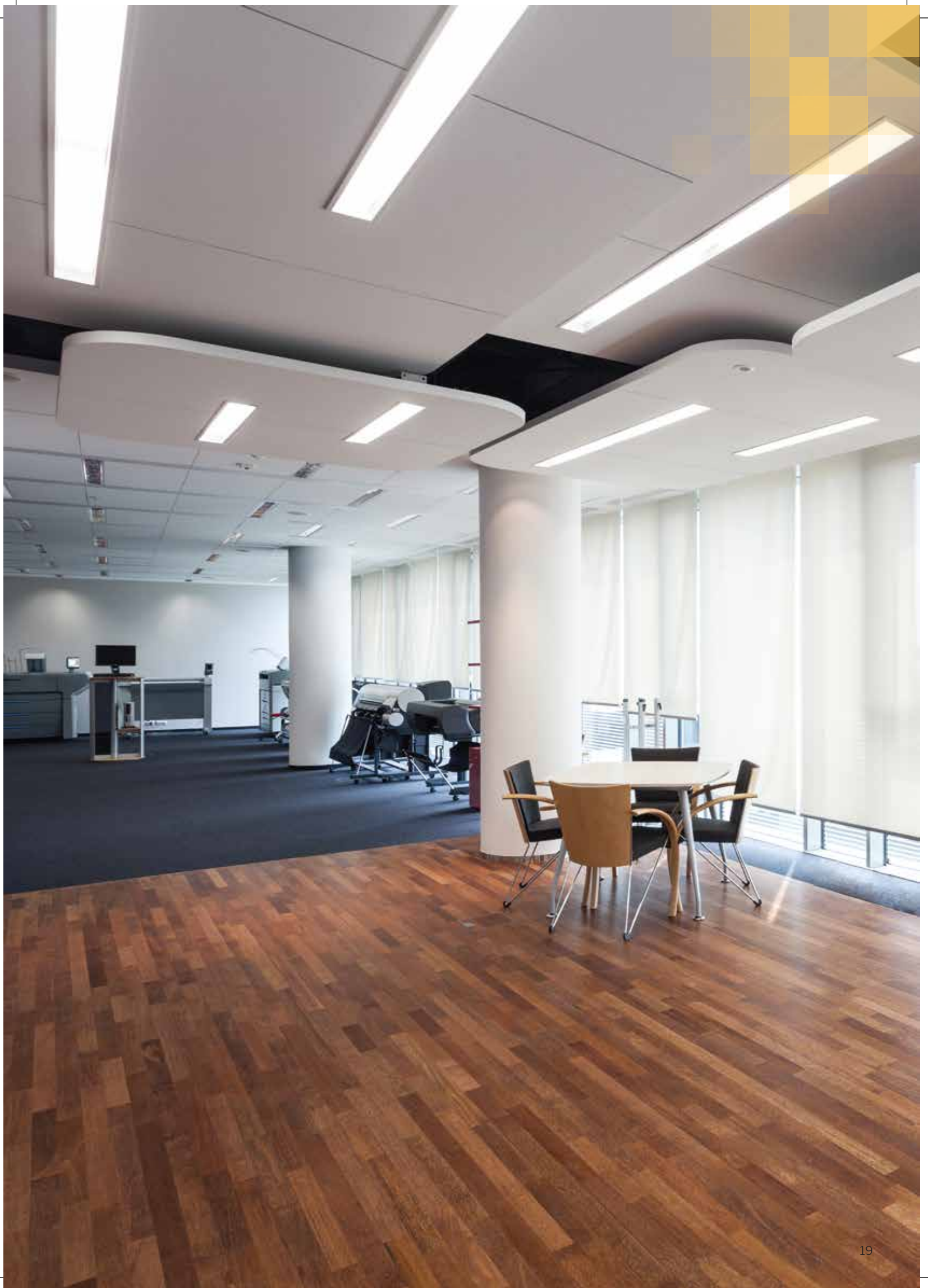

SUSPENDED LINEAR UP DOWN TYPE

SLENDO UDL

40W/65W

Aesthetically designed LED linear fixture suitable for suspended updown type with housing made of high quality extruded aluminium alloy including die-cast aluminium end cap. These series are also available with seamless continuous lighting system ensuring no visible dark spot or light leakages.

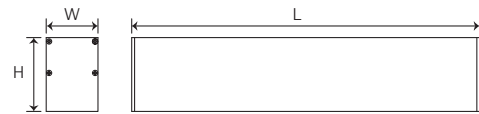
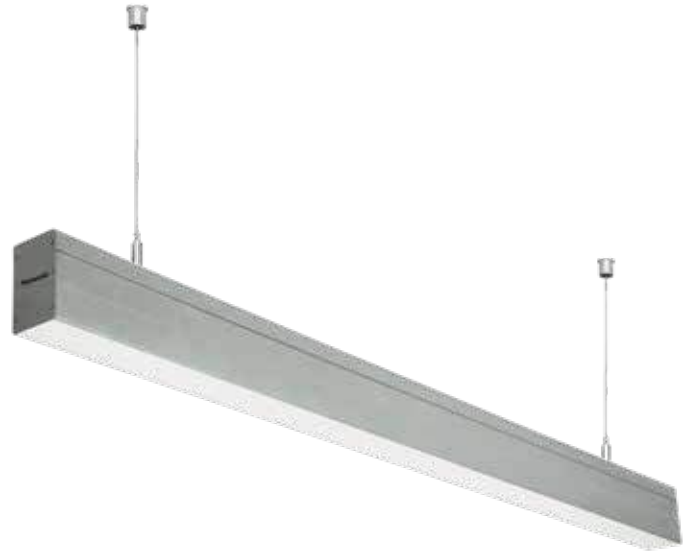

High on Efficacy
Efficacy of 100lm/W



Special Features
Up/down version in suspended mounting options, LILO on request



Wide Operating Voltage / Rated Voltage
140-270V AC /
220-240V AC/50Hz



Safe & Reliable
THD<10%,
Inbuilt Surge Protection: 4kV
Class-I product



Internal Isolated Driver
Protects the output /secondary side from any disturbance on the Input /Primary side ensuring safe operation



Higher Life
Life: 50,000 BH @ L70B50



Operating Temperature
0°C to +45°C

APPLICATIONS

- Corporate Offices
- Modern Workspaces
- Banks
- Software Centres
- Hospitals



TECHNICAL SPECIFICATION

Product Code	System Wattage (W)	LxWxH (mm)	Cutout (mm)	THD	Colour Temp. (CCT)
PLHM04404	40W	1200x54x88	—	≤ 10%	4000K
PLHM04406	40W	1200x54x88	—	≤ 10%	6000K
PLHM04654	65W	1200x54x88	—	≤ 10%	4000K
PLHM04656	65W	1200x54x88	—	≤ 10%	6000K

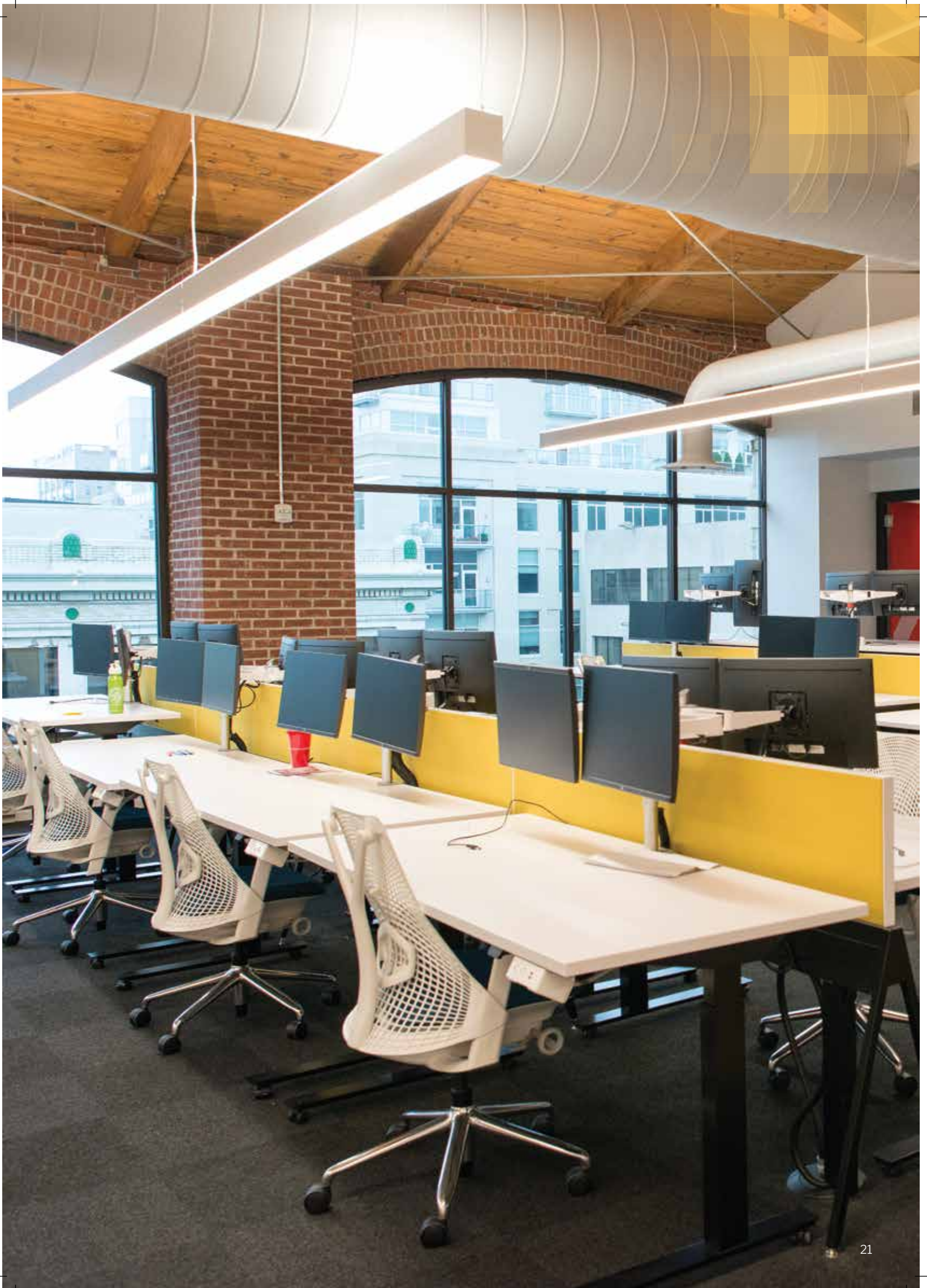

SUSPENDED LINEAR LIGHT

SLENDO ADV

10W/14W/18W/28W/36W/56W

Slendo Plus ADV Suspended Linear light comprises of Aluminium Extrusion with PMMA sliding diffuser, PC end caps and clutch wire suspension kit for mounting arrangement with energy efficient Isolated electronic driver.

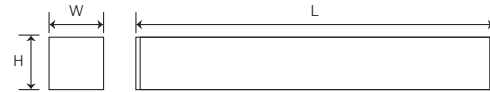

High on Efficacy

Efficacy of 110lm/W



Special Features

- Different wattages for standalone and continuous mounting versions
- Easy LILO arrangement using inbuilt male female connector



Wide Operating Voltage / Rated Voltage

140-270V AC /
220-240V AC/50Hz



Safe & Reliable

THD<10%,
Inbuilt Surge Protection: 3KV
Power Factor >0.95, Class-I product



Constant Current Isolated Driver

Protects the output /secondary side from any disturbance on the Input / Primary side ensuring safe operation



Higher Life

Life: 50,000 BH @ L70B50



Operating Temperature

0°C to +45°C

APPLICATIONS

Corporate Offices

Modern Workspaces

Banks

Software Centres

Hospitals

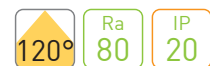

TECHNICAL SPECIFICATION

Product Code	System Wattage (W)	LxWxH (mm)	Cutout (mm)	THD	Colour Temp. (CCT)
PLHM10144	14W	605x52x75	—	≤ 10%	4000K
PLHM10148	14W	605x52x75	—	≤ 10%	5700K
PLHM10284	28W	1200x52x75	—	≤ 10%	4000K
PLHM10288	28W	1200x52x75	—	≤ 10%	5700K
PLHM10564	56W	2385x52x75	—	≤ 10%	4000K
PLHM10568	56W	2385x52x75	—	≤ 10%	5700K
PLHM09104	10W [#]	605x52x75	—	≤ 10%	4000K
PLHM09108	10W [#]	605x52x75	—	≤ 10%	5700K
PLHM09184	18W [#]	1200x52x75	—	≤ 10%	4000K
PLHM09188	18W [#]	1200x52x75	—	≤ 10%	5700K
PLHM09364	36W [#]	2385x52x75	—	≤ 10%	4000K
PLHM09368	36W [#]	2385x52x75	—	≤ 10%	5700K

[#] Continuous mounted version

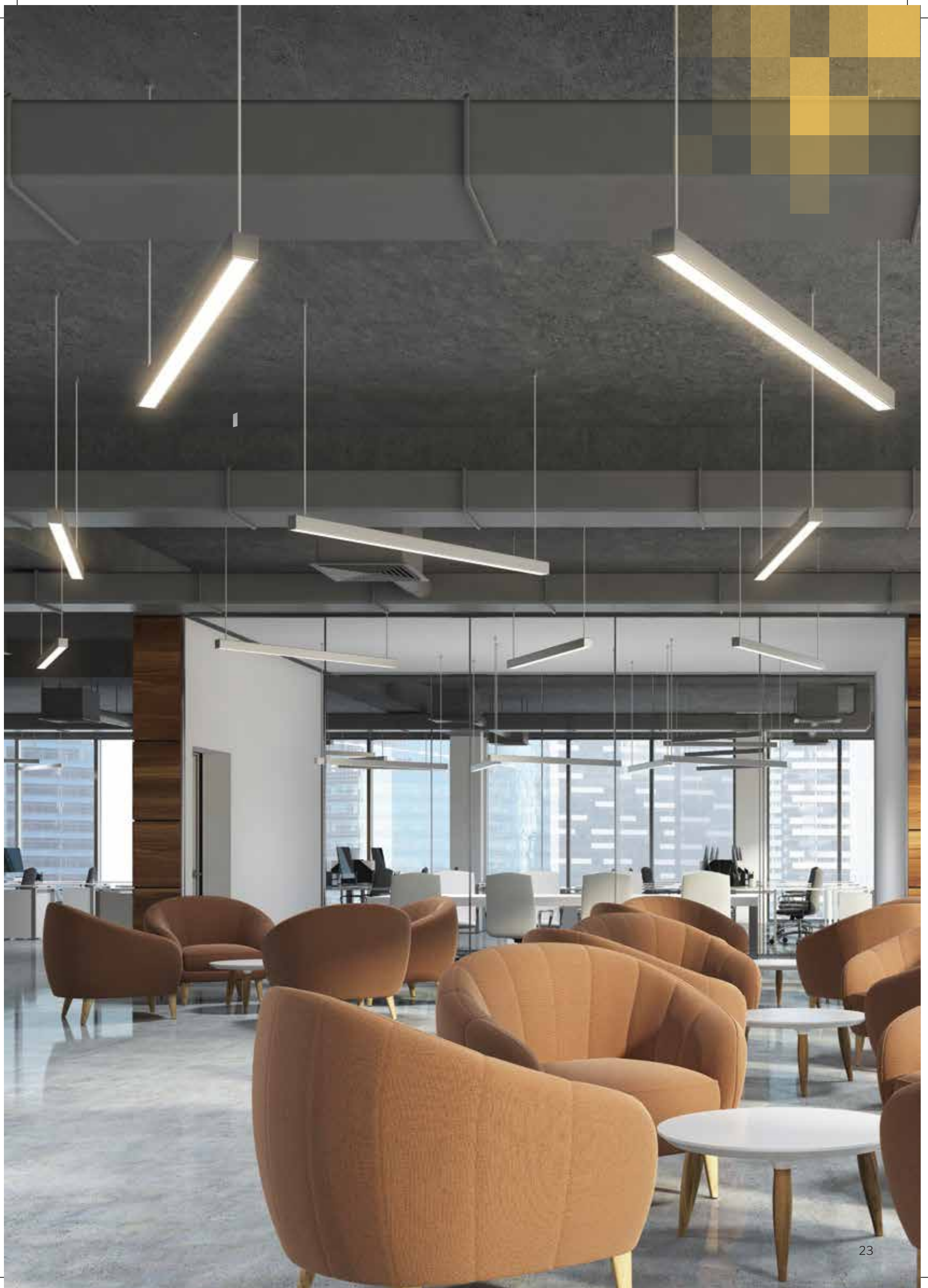

SUSPENDED LINEAR SHAPES

SLENDO FLEXIBLE

18W/28W/36W

Slendo Flexible Linear light comprises of Aluminium Extrusion with PMMA sliding diffuser, PC end caps and clutch wire suspension kit for mounting arrangement with energy efficient Isolated electronic driver.



X, +, V, L, T, Y



High on Efficacy
Efficacy of 110lm/W



Special Features
- Different shapes available for flexibility in design
- Easy LILO arrangement using inbuilt male female connector



Wide Operating Voltage / Rated Voltage
140-270V AC /
220-240V AC/50Hz



Safe & Reliable
THD<10%,
Inbuilt Surge Protection: 3KV
Power Factor >0.95, Class-I product



Constant Current Isolated Driver
Protects the output / secondary side from any disturbance on the Input / primary side ensuring safe operation



Higher Life
Life: 50,000 BH @ L70B50



Operating Temperature
0°C to +45°C

APPLICATIONS

Corporate Offices
Modern Workspaces
Banks
Software Centres
Hospitals



TECHNICAL SPECIFICATION

Product Code	System Wattage (W)	LxWxH per Arm (mm)	Cutout (mm)	THD	Colour Temp. (CCT)
PLHM13184	18W	600x52x75	—	≤10%	4000K
PLHM13188	18W	600x52x75	—	≤10%	5700K
PLHM14184	18W	602x52x75	—	≤10%	4000K
PLHM14188	18W	602x52x75	—	≤10%	5700K
PLHM15284	28W	594x42x75	—	≤10%	4000K
PLHM15288	28W	594x42x75	—	≤10%	5700K
PLHM16284	28W	585x52x75	—	≤10%	4000K
PLHM16288	28W	585x52x75	—	≤10%	5700K
PLHM11364	36W	600x52x75	—	≤10%	4000K
PLHM11368	36W	600x52x75	—	≤10%	5700K
PLHM12364	36W	605x52x75	—	≤10%	4000K
PLHM12368	36W	605x52x75	—	≤10%	5700K



DECO LINEAR - DEEP RECESSED

SLENDO MAX

28W/36W

Unique design with deep recessed diffuser to reduce strain on eye. The 28W down type & 36W up-down type deep recessed linear comprises of aluminium housing with clutchwise suspension kit for suspended mounting.

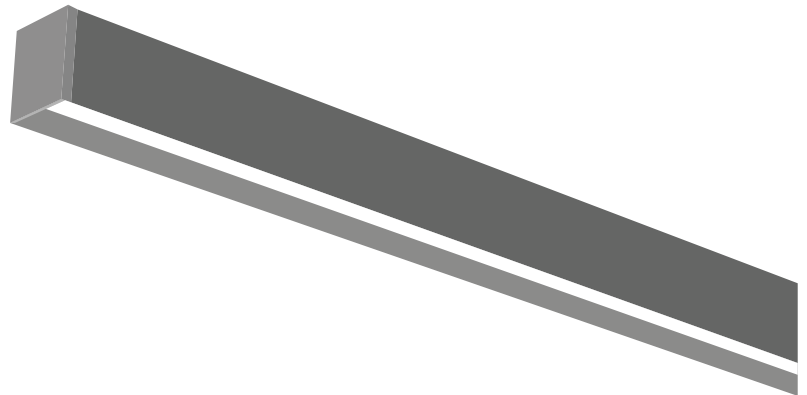

High on Efficacy

28W for direct &
36W for direct/indirect illumination
105lm/W Efficacy



Housing

Al. extrusion with white powder coating



Wide Operating Voltage / Rated Voltage

140-270V AC /
220-240V AC/50Hz



Safe & Reliable

THD<10%,
Inbuilt Surge Protection: 3KV
Power Factor >0.95, Class-I product



Integrated Isolated Driver

Protects the output / secondary side from any disturbance on the Input / primary side ensuring safe operation



Higher Life

Life: 50,000 BH @ L70B50



Operating Temperature

0°C to +45°C

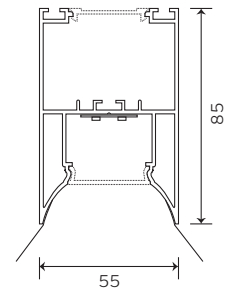

APPLICATIONS

- Corporate Offices
- Modern Workspaces
- Banks
- Software Centres
- Hospitals



TECHNICAL SPECIFICATION

Product Code	System Wattage (W)	LxWxH (mm)	Cutout (mm)	THD	Colour Temp. (CCT)
PLHM05283	28W	1200x55x86	—	≤10%	3000K
PLHM05284	28W	1200x55x86	—	≤10%	4000K
PLHM05288	28W	1200x55x86	—	≤10%	5700K
PLHM06363	36W	1200x55x86	—	≤10%	3000K
PLHM06364	36W	1200x55x86	—	≤10%	4000K
PLHM06368	36W	1200x55x86	—	≤10%	5700K



DECO LINEAR - LASER LINEA

SLENDO MAX

28W/36W

The 28W down type & 36W up-down type laser linear with lens comprises of aluminium extrusion housing with clutch wire suspension kit for suspended mounting.

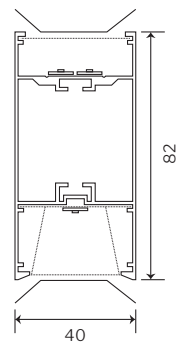

UGR < 10



Housing

Al. extrusion with black powder coating



Wide Operating Voltage / Rated Voltage

140-270V AC /
220-240V AC/50Hz



Safe & Reliable

THD<10%,
Inbuilt Surge Protection: 3kV
Power Factor >0.95, Class-I product



Integrated Isolated Driver

Protects the output / secondary side from any disturbance on the Input / primary side ensuring safe operation



Higher Life

Life: 50,000 BH @ L70B50



Operating Temperature

0°C to +45°C

APPLICATIONS

- Corporate Offices
- Modern Workspaces
- Banks
- Software Centres
- Hospitals



TECHNICAL SPECIFICATION

Product Code	System Wattage (W)	LxWxH (mm)	Cutout (mm)	THD	Colour Temp. (CCT)
PLHM07283	28W	1128x40x82	—	≤10%	3000K
PLHM07284	28W	1128x40x82	—	≤10%	4000K
PLHM07288	28W	1128x40x82	—	≤10%	5700K
PLHM08363	36W	1128x40x82	—	≤10%	3000K
PLHM08364	36W	1128x40x82	—	≤10%	4000K
PLHM08368	36W	1128x40x82	—	≤10%	5700K

RECESSED LINEAR LIGHT

SLENDO R

15/18W/25W/35W

Aesthetically designed LED linear fixture with housing made of high quality extruded aluminium alloy including die-cast aluminium end cap. These series are also available with seamless continuous lighting system ensuring no visible dark spot or light gaps.

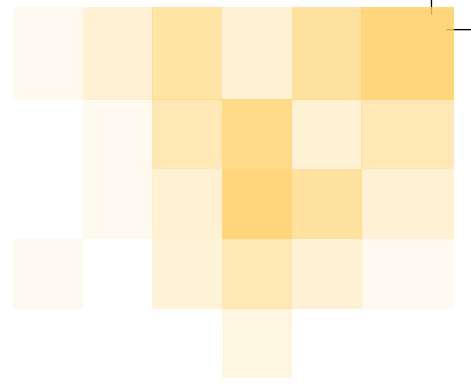

Efficacy

Efficacy of 100lm/W



Housing

- Aluminium extrusion with powder coating
- Aluminium end caps and spring clamps for recess mounting



Wide Operating Voltage / Rated Voltage

140-270V AC /
220-240V AC/50Hz



Safe & Reliable

THD<10%,
Inbuilt Surge Protection: 4KV
Power Factor >0.9, Class-I product



Integrated Isolated Driver

Protects the output / secondary side from any disturbance on the Input / primary side ensuring safe operation



Higher Life

Life: 50,000 BH @ L70B50



Operating Temperature

0°C to +45°C

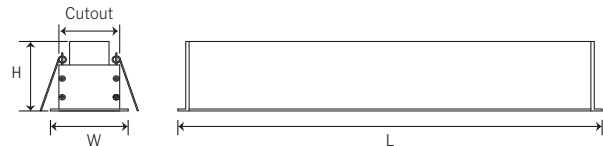

APPLICATIONS

- Offices
- Corridors & Libraries
- Meeting room
- Educational Facilities
- Reception Area



TECHNICAL SPECIFICATION

Product Code	System Wattage (W)	LxWxH (mm)	Cutout (mm)	THD	Colour Temp. (CCT)
PLRM01154	15W	620x69x71	605x55	≤ 10%	4000K
PLRM01156	15W	620x69x71	605x55	≤ 10%	6000K
PLRM01254	25W	1220x69x71	1200x55	≤ 10%	4000K
PLRM01256	25W	1220x69x71	1200x55	≤ 10%	6000K
PLRM01184	18W	620x69x71	605x55	≤ 10%	4000K
PLRM01186	18W	620x69x71	605x55	≤ 10%	6000K
PLRM01354	35W	1220x69x71	1200x55	≤ 10%	4000K
PLRM01356	35W	1220x69x71	1200x55	≤ 10%	6000K

ALUMINIUM DOWN LIGHT

ARUMI

6W/9W/12W/15W/18W/20W

The aluminium recessed down light comprises of casted aluminium housing with high quality diffuser for uniform light distribution.

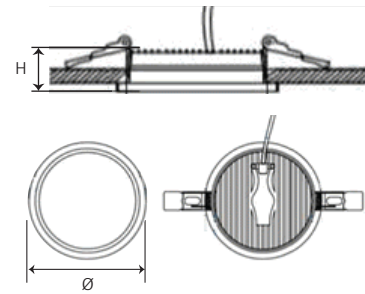

Efficacy

6W, 9W - 100 lm/W
12W, 15W, 18W & 20W - 110 lm/W



Low Depth

Suitable for ceiling wherein depth between True ceiling and False ceiling is constraint



Wide Operating Voltage / Rated Voltage

140-270V AC /
220-240V AC/50Hz



Safe & Reliable

THD<10%,
Inbuilt Surge Protection: 2KV
Class-II product, IK05



Non Integrated Isolated Driver

No Electric Shocks. Protects the output / secondary side from any disturbance on the Input / primary side ensuring safe operation



Higher Life

Life: 50,000 BH @ L70B50



Operating Temperature

0°C to +45°C

APPLICATIONS

Residences

Corporate Offices

Museums

Retail Stores

Shopping Malls

Airport Lounges

Restaurants

Hotels



TECHNICAL SPECIFICATION

Product Code	System Wattage (W)	DiaxH (mm)	Cutout (mm)	THD	Colour Temp. (CCT)
PDLM26063 / PDLM26064 / PDLM26068	6W	94x26	Ø82	≤10%	3000K/4000K/6500K
PDLM26093 / PDLM26094 / PDLM26098	9W	94x26	Ø82	≤10%	3000K/4000K/6500K
PDLM26123 / PDLM26124 / PDLM26128	12W	139x33	Ø125	≤10%	3000K/4000K/6500K
PDLM26153 / PDLM26154 / PDLM26158	15W	139x33	Ø125	≤10%	3000K/4000K/6500K
PDLM26183 / PDLM26184 / PDLM26188	18W	169x33	Ø156	≤10%	3000K/4000K/6500K
PDLM26203 / PDLM26204 / PDLM26208	20W	169x33	Ø156	≤10%	3000K/4000K/6500K

PC DOWN LIGHT

SPUR

5W/10W/15W

Recess mounting circular LED downlight luminaire with PC housing, anti-glare diffuser and separate energy efficient electronic driver.



Wide wattage selection
5W, 10W, 15W, 20W



Low Depth
Suitable for ceiling wherein depth between True ceiling and False ceiling is constraint



Wide Operating Voltage / Rated Voltage
100-330V AC /
220-240V AC/50Hz



Safe & Reliable
THD < 20%,
Inbuilt Surge Protection: 2.5kV
Class-II product



Driver Type
Non Integral Energy Efficient
Electronic driver



Higher Life
Life: 25,000 BH @ L70B50



Operating Temperature
0°C to +45°C

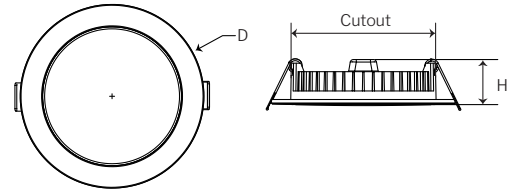

APPLICATIONS

Residences

Corporate Offices

Museums

Retail Stores

Shopping Malls

Airport Lounges

Restaurants

Hotels



TECHNICAL SPECIFICATION

Product Code	System Wattage (W)	DiaxH (mm)	Cutout (mm)	THD	Colour Temp. (CCT)
PDLM12053 / PDLM12054 / PDLM12057	5W	120x30	Ø102	≤ 20%	3000K/4000K/6500K
PDLM12103 / PDLM12104 / PDLM12107	10W	150x30	Ø128	≤ 20%	3000K/4000K/6500K
PDLM12153 / PDLM12154 / PDLM12157	15W	198x30	Ø178	≤ 20%	3000K/4000K/6500K
PDLM12203 / PDLM12204 / PDLM12207	20W	198x30	Ø178	≤ 20%	3000K/4000K/6500K

CIRCULAR ALUMINIUM PANEL LIGHT

IGNITOS MODAN

10W/15W/20W

Recess mounted slim circular type LED panel with die-cast aluminium housing and smooth powder coated finish with anti-glare UV stabilized diffuser and separate energy efficient electronic driver.



Aluminium Housing

Die-cast Aluminium housing with anti-glare UV stabilized diffuser



Low Depth

Suitable for ceiling wherein depth between True ceiling and False ceiling is constraint



Wide Operating Voltage / Rated Voltage

100-300V AC /
220-240V AC/50Hz



Safe & Reliable

THD<20%,
Inbuilt Surge Protection: 2.5kV
Class-I product



Driver Type

Non Integral Energy Efficient
Electronic driver



Higher Life

Life: 30,000 BH @ L70B50



Operating Temperature

0°C to +45°C

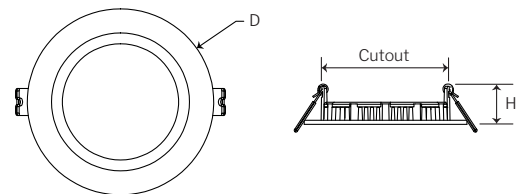

APPLICATIONS

Residences

Corporate Offices

Retail Stores

Shopping Malls

Restaurants



TECHNICAL SPECIFICATION

Product Code	System Wattage (W)	DiaxH (mm)	Cutout (mm)	THD	Colour Temp. (CCT)
PPAM11103BS	10W	145x25	Ø130	≤ 20%	3000K
PPAM11104BS	10W	145x25	Ø130	≤ 20%	4000K
PPAM11106BS	10W	145x25	Ø130	≤ 20%	6000K
PPAM11153BS	15W	170x25	Ø155	≤ 20%	3000K
PPAM11154BS	15W	170x25	Ø155	≤ 20%	4000K
PPAM11156BS	15W	170x25	Ø155	≤ 20%	6000K
PPAM11203BS	20W	190x25	Ø175	≤ 20%	3000K
PPAM11204BS	20W	190x25	Ø175	≤ 20%	4000K
PPAM11206BS	20W	190x25	Ø175	≤ 20%	6000K

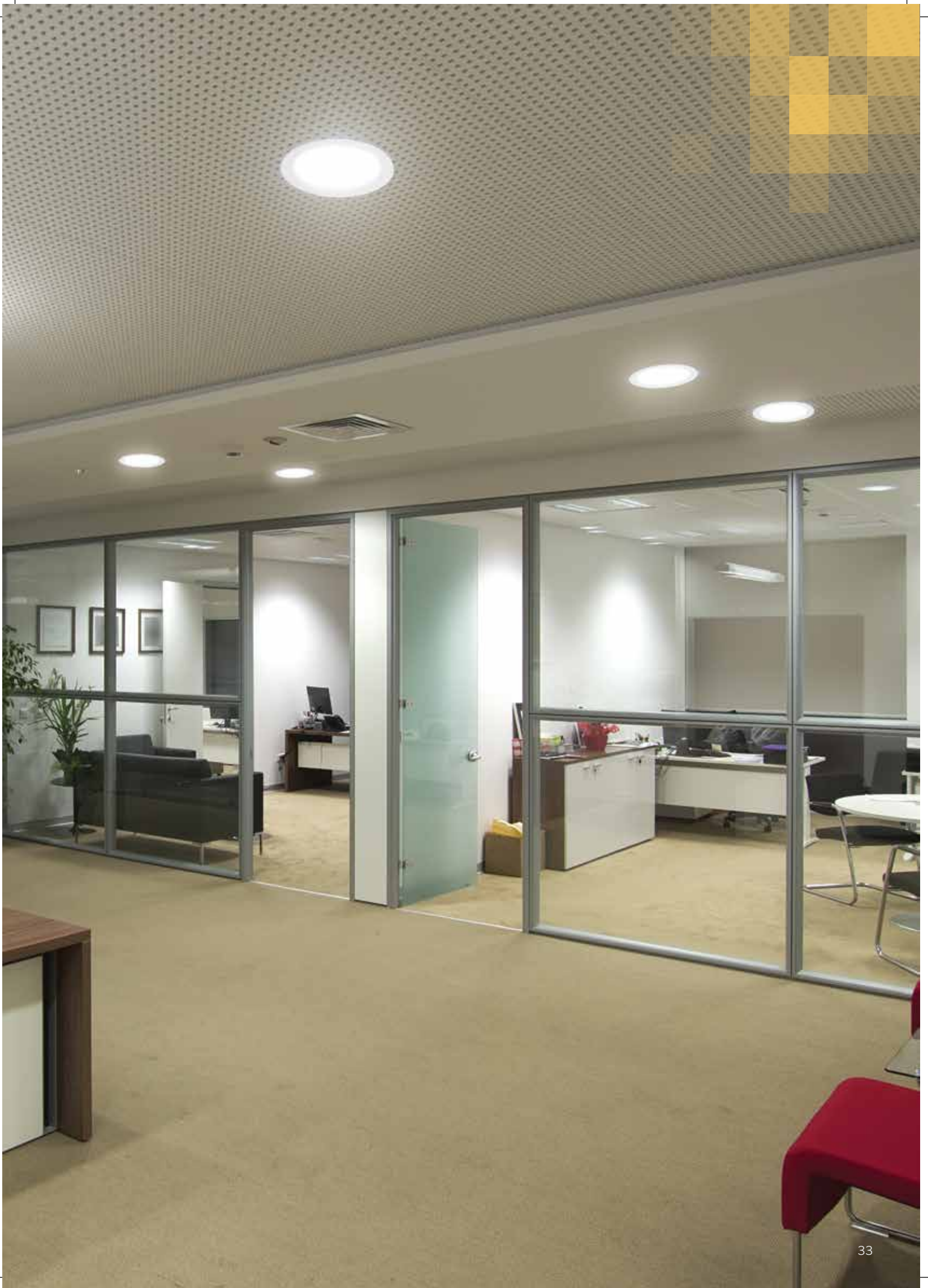

SQUARE ALUMINIUM PANEL LIGHT

IGNITOS MODAN

10W/15W/20W

Slim square type LED Panel with die-cast aluminium housing and smooth powder coated finish with anti-glare UV stabilized diffuser and non-integral energy efficient electronic driver.



Aluminium Housing

Die-cast Aluminium housing with anti-glare UV stabilized diffuser



Low Depth

Suitable for ceiling wherein depth between True ceiling and False ceiling is constraint



Wide Operating Voltage / Rated Voltage

100-300V AC /
220-240V AC/50Hz



Safe & Reliable

THD<20%,
Inbuilt Surge Protection: 2.5kV
Class-I product



Driver Type

Non Integral Energy Efficient
Electronic driver



Higher Life

Life: 30,000 BH @ L70B50



Operating Temperature

0°C to +45°C

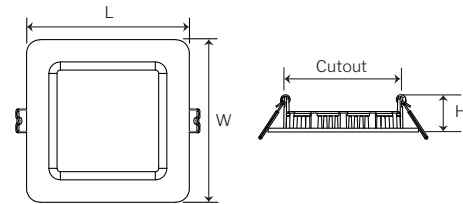

APPLICATIONS

Residences

Corporate Offices

Retail Stores

Shopping Malls

Restaurants



TECHNICAL SPECIFICATION

Product Code	System Wattage (W)	LxWxH (mm)	Cutout (mm)	THD	Colour Temp. (CCT)
PPAM12103BS	10W	145x145x25	132x132	≤ 20%	3000K
PPAM12104BS	10W	145x145x25	132x132	≤ 20%	4000K
PPAM12106BS	10W	145x145x25	132x132	≤ 20%	6000K
PPAM12153BS	15W	170x170x25	156x156	≤ 20%	3000K
PPAM12154BS	15W	170x170x25	156x156	≤ 20%	4000K
PPAM12153BS	15W	170x170x25	156x156	≤ 20%	6000K
PPAM12203BS	20W	190x190x25	177x177	≤ 20%	3000K
PPAM12204BS	20W	190x190x25	177x177	≤ 20%	4000K
PPAM12206BS	20W	190x190x25	177x177	≤ 20%	6000K

CIRCULAR ALUMINIUM PANEL LIGHT

CAMBER MODAN

10W/15W/20W

Surface mounting circular LED Down Light luminaire with die-cast aluminium housing in white powder coating finish, anti-glare diffuser and energy efficient electronic driver.

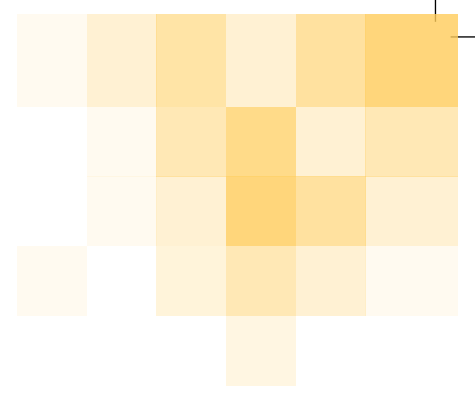

Aluminium Housing

Die-cast Aluminium housing with anti-glare UV stabilized diffuser



Wide Operating Voltage / Rated Voltage

100-300V AC /
220-240V AC/50Hz



Safe & Reliable

THD<20%,
Inbuilt Surge Protection: 2.5kV
*Class-I product



Driver Type

Non Integral Energy Efficient
Electronic driver



Higher Life

Life: 30,000 BH @ L70B50



Operating Temperature

0°C to +45°C

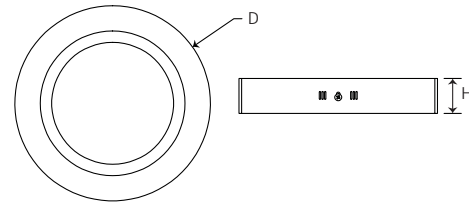

APPLICATIONS

Residences

Corporate Offices

Retail Stores

Shopping Malls

Restaurants

Hotels



TECHNICAL SPECIFICATION

Product Code	System Wattage (W)	DiaxH (mm)	Cutout (mm)	THD	Colour Temp. (CCT)
PDLM10103BS	10W	120x35	—	≤ 20%	3000K
PDLM10104BS	10W	120x35	—	≤ 20%	4000K
PDLM10106BS	10W	120x35	—	≤ 20%	6000K
PDLM10153BS	15W	170x35	—	≤ 20%	3000K
PDLM10154BS	15W	170x35	—	≤ 20%	4000K
PDLM10156BS	15W	170x35	—	≤ 20%	6000K
PDLM10203BS	20W	225x35	—	≤ 20%	3000K
PDLM10204BS	20W	225x35	—	≤ 20%	4000K
PDLM10206BS	20W	225x35	—	≤ 20%	6000K

SQUARE ALUMINIUM PANEL LIGHT

CAMBER MODAN

10W/15W/20W

Surface mounting square LED Down Light luminaire with die-cast aluminium housing in white powder coating finish, anti-glare diffuser and energy efficient electronic driver.



Aluminium Housing

Die-cast Aluminium housing with anti-glare UV stabilized diffuser



Wide Operating Voltage / Rated Voltage

100-300V AC /
220-240V AC/50Hz



Safe & Reliable

THD<20%,
Inbuilt Surge Protection: 2.5kV
*Class-I product



Driver Type

Non Integral Energy Efficient
Electronic driver



Higher Life

Life: 30,000 BH @ L70B50



Operating Temperature

0°C to +45°C

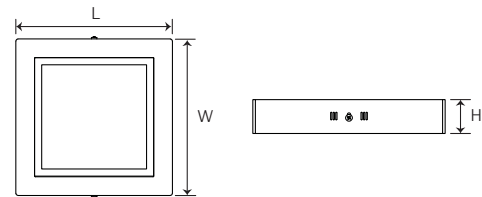

APPLICATIONS

Residences

Corporate Offices

Retail Stores

Shopping Malls

Restaurants

Hotels



TECHNICAL SPECIFICATION

Product Code	System Wattage (W)	LxWxH (mm)	Cutout (mm)	THD	Colour Temp. (CCT)
PDLM11103BS	10W	120x120x35	—	≤ 20%	3000K
PDLM11104BS	10W	120x120x35	—	≤ 20%	4000K
PDLM11106BS	10W	120x120x35	—	≤ 20%	6000K
PDLM11153BS	15W	170x170x35	—	≤ 20%	3000K
PDLM11154BS	15W	170x170x35	—	≤ 20%	4000K
PDLM11156BS	15W	170x170x35	—	≤ 20%	6000K
PDLM11203BS	20W	225x225x35	—	≤ 20%	3000K
PDLM11204BS	20W	225x225x35	—	≤ 20%	4000K
PDLM11206BS	20W	225x225x35	—	≤ 20%	6000K

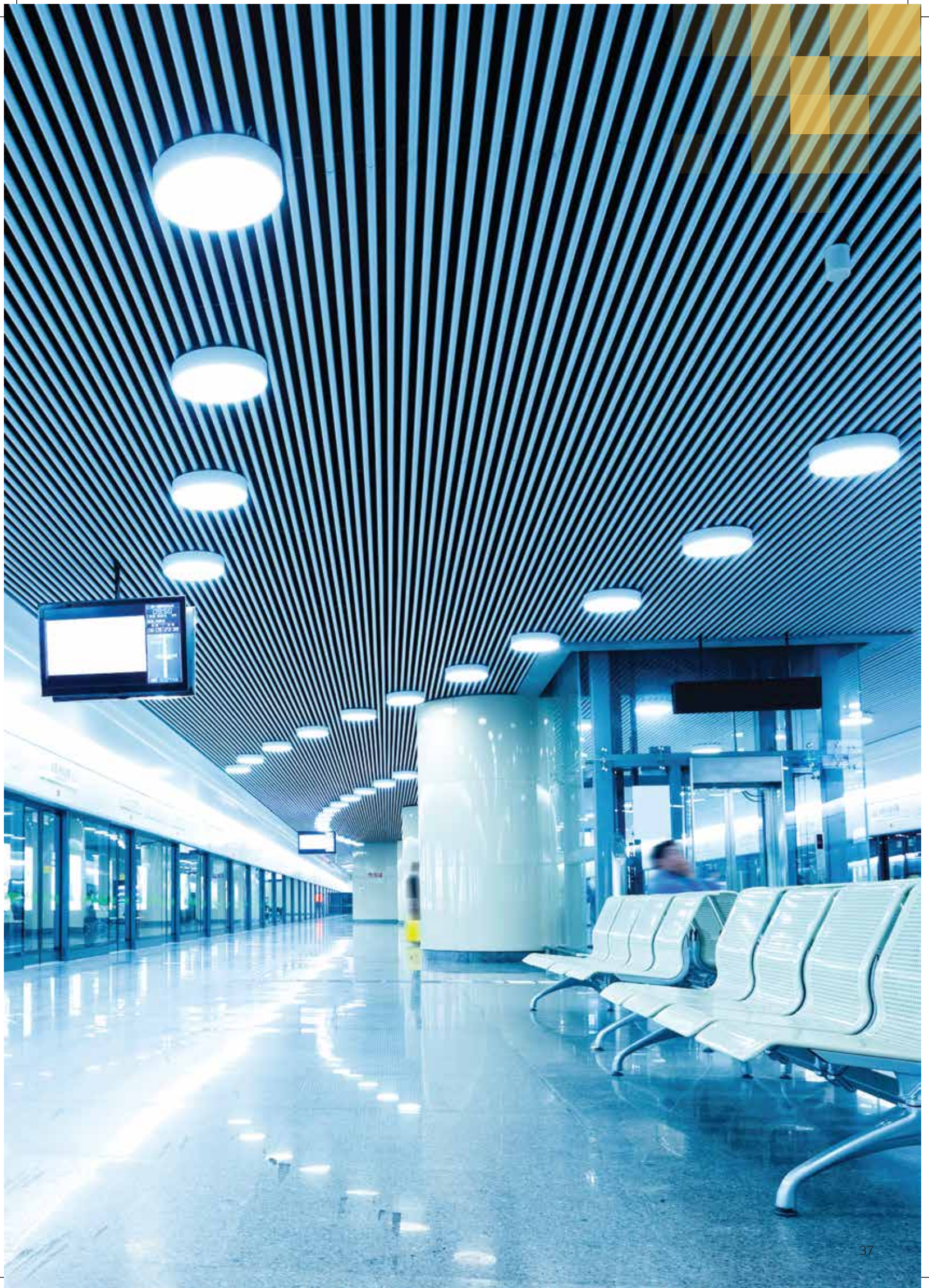

CIRCULAR SUSPENDED LIGHT

SPINDLE

25W/32W/40W

Circular suspended mounted LED luminaire comprises of CRCA housing matt powder coated in black. The LED clusters are assembled in the body & high efficiency translucent frosted diffuser is used for uniform glare-free light distribution.



Available in 3 sizes

Dia: 300mm, 450mm & 600mm



Mounting System

Suspended mounted



Wide Operating Voltage / Rated Voltage

140-270V AC /
220-240V AC/50Hz



Safe & Reliable

THD<10%,
Inbuilt Surge Protection: 2.5KV
Class-I product, IK05



Non Integrated Isolated Driver

No Electric Shocks. Protects the output / secondary side from any disturbance on the Input / primary side ensuring safe operation



Higher Life

Life: 50,000 BH @ L70B50



Operating Temperature

0°C to +45°C

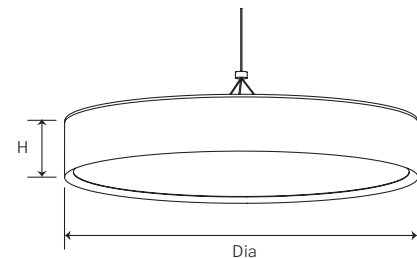

APPLICATIONS

Modern Office

Meeting Room

Auditorium

Assembly Hall



TECHNICAL SPECIFICATION

Product Code	System Wattage (W)	DiaxH (mm)	Cutout (mm)	THD	Colour Temp. (CCT)
PDLM20254	25W	300x85	—	≤10%	4000K
PDLM20258	25W	300x85	—	≤10%	5700K
PDLM20324	32W	450x85	—	≤10%	4000K
PDLM20328	32W	450x85	—	≤10%	5700K
PDLM20404	40W	600x95	—	≤10%	4000K
PDLM20408	40W	600x95	—	≤10%	5700K

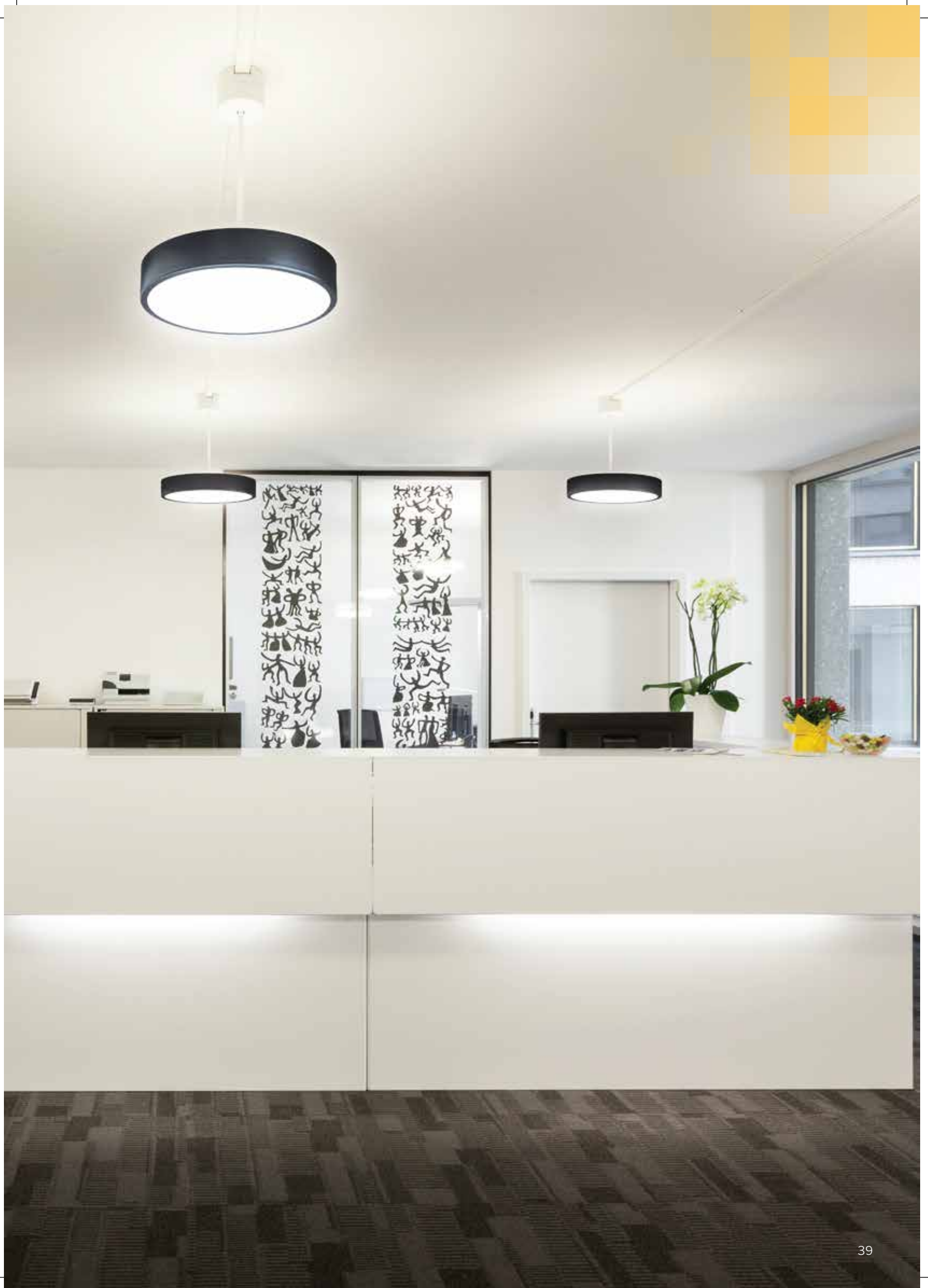

CIRCULAR SURFACE LIGHT

SPINDLE

25W/32W/40W

Cylindrical surface mounted LED luminaire comprises of CRCA housing matt powder coated in black. The LED clusters are assembled in the body & high efficiency translucent frosted diffuser is used for uniform glare-free light distribution.

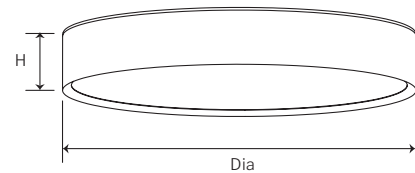

Available in 3 sizes

Dia: 300mm, 450mm & 600mm



Mounting System

Surface mounted



Wide Operating Voltage / Rated Voltage

140-270V AC /
220-240V AC/50Hz



Safe & Reliable

THD<10%,
Inbuilt Surge Protection: 2.5KV
Class-I product, IK05



Non Integrated Isolated Driver

No Electric Shocks. Protects the output / secondary side from any disturbance on the Input / primary side ensuring safe operation



Higher Life

Life: 50,000 BH @ L70B50



Operating Temperature

0°C to +45°C

APPLICATIONS

Modern Office

Meeting Room

Auditorium

Assembly Hall



TECHNICAL SPECIFICATION

Product Code	System Wattage (W)	DiaxH (mm)	Cutout (mm)	THD	Colour Temp. (CCT)
PDLM21254	25W	300x85	—	≤10%	4000K
PDLM21258	25W	300x85	—	≤10%	5700K
PDLM21324	32W	450x85	—	≤10%	4000K
PDLM21328	32W	450x85	—	≤10%	5700K
PDLM21404	40W	600x95	—	≤10%	4000K
PDLM21408	40W	600x95	—	≤10%	5700K

CYLINDRICAL SUSPENDED LIGHT

PEAR

12W/20W

Cylindrical suspended mounted LED luminaire comprises of Al housing matt powder coated in black is used for modern offices, recreation area & other interiors. Special translucent diffuser used for better lighting distribution.



Aluminium Housing

Matt powder coated in black, special translucent diffuser for glare-free light distribution



Mounting System

Suspended mounted



Wide Operating Voltage / Rated Voltage

140-270V AC /
220-240V AC/50Hz



Safe & Reliable

THD<10%,
Inbuilt Surge Protection: 2.5KV
Class-I product, IK05



Isolated Integrated Driver

No Electric Shocks. Protects the output / secondary side from any disturbance on the Input / primary side ensuring safe operation



Higher Life

Life: 50,000 BH @ L70B50



Operating Temperature

0°C to +45°C

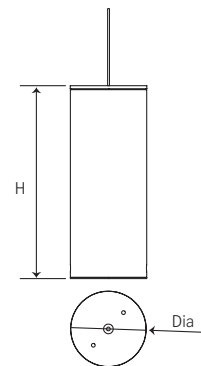

APPLICATIONS

Modern Office
Corridors & Libraries
Museums
Reception Area
Recreation Area



TECHNICAL SPECIFICATION

Product Code	System Wattage (W)	DiaxH (mm)	Cutout (mm)	THD	Colour Temp. (CCT)
PDLM18124	12W	102x200	—	≤10%	4000K
PDLM18128	12W	102x200	—	≤10%	5700K
PDLM18204	20W	102x200	—	≤10%	4000K
PDLM18208	20W	102x200	—	≤10%	5700K

CYLINDRICAL SURFACE LIGHT

PEAR

12W/20W

Cylindrical surface mounted LED luminaire comprises of Al housing matt powder coated in black. The LED clusters are assembled in the body & high efficiency translucent diffuser is used for uniform glare-free light distribution.



Aluminium Housing

Matt powder coated in black, special translucent diffuser for glare-free light distribution



Mounting System

Surface mounted



Wide Operating Voltage / Rated Voltage

140-270V AC / 220-240V AC/50Hz



Safe & Reliable

THD<10%,
Inbuilt Surge Protection: 2.5KV
Class-I product, IK05



Isolated Integrated Driver

No Electric Shocks. Protects the output / secondary side from any disturbance on the Input / primary side ensuring safe operation



Higher Life

Life: 50,000 BH @ L70B50



Operating Temperature

0°C to +45°C

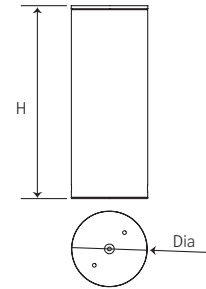

APPLICATIONS

Modern Office
Corridors & Libraries
Museums
Reception Area
Recreation Area



TECHNICAL SPECIFICATION

Product Code	System Wattage (W)	DiaxH (mm)	Cutout (mm)	THD	Colour Temp. (CCT)
PDLM19124	12W	102x200	—	≤10%	4000K
PDLM19128	12W	102x200	—	≤10%	5700K
PDLM19204	20W	102x200	—	≤10%	4000K
PDLM19208	20W	102x200	—	≤10%	5700K



ALUMINIUM TECHZONE

SLENDO TECH PLUS

14W/18W/22W/28W/44W/36W/56W

The recess mounted techzone luminaire comprises of aluminium extrusion housing with PMMA sliding diffuser.



High on Efficacy

Max upto 140 lm/W



Special Features

- Different wattages for standalone & continuous mounting versions
- Easy loop in loop out arrangements using male female connection



Wide Operating Voltage / Rated Voltage

140-270V AC /
220-240V AC/50Hz



Safe & Reliable

THD<10%,
Inbuilt Surge Protection: 3kV
Class-I product, IK05



Non Integral Isolated Driver

Protects the output/secondary side from any disturbance on the input/primary side ensuring safe operations.



Higher Life

Life: 50,000 BH @ L70B50



Operating Temperature

0°C to +45°C

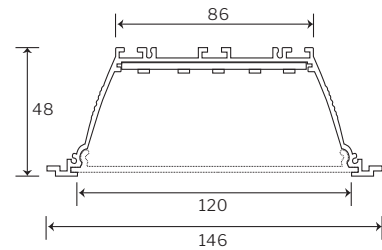

APPLICATIONS

Corporate Office

Meeting Room

Corridors

Libraries



TECHNICAL SPECIFICATION

Product Code	System Wattage (W)	LxWxH (mm)	THD	Colour Temp. (CCT)
PTZM03184 / PTZM03188	18W	1195x146x48	≤ 10%	4000K/5700K
PTZM04284 / PTZM04288	28W	1195x146x48	≤ 10%	4000K/5700K
PTZM03364 / PTZM03368	36W	2395x146x48	≤ 10%	4000K/5700K
PTZM04564 / PTZM04568	56W	2395x146x48	≤ 10%	4000K/5700K
PTZM03144 / PTZM03148	14W	1195x146x48	≤ 10%	4000K/5700K
PTZM04224 / PTZM04228	22W	1195x146x48	≤ 10%	4000K/5700K
PTZM03284 / PTZM03288	28W	2395x146x48	≤ 10%	4000K/5700K
PTZM04444 / PTZM04448	44W	2395x146x48	≤ 10%	4000K/5700K

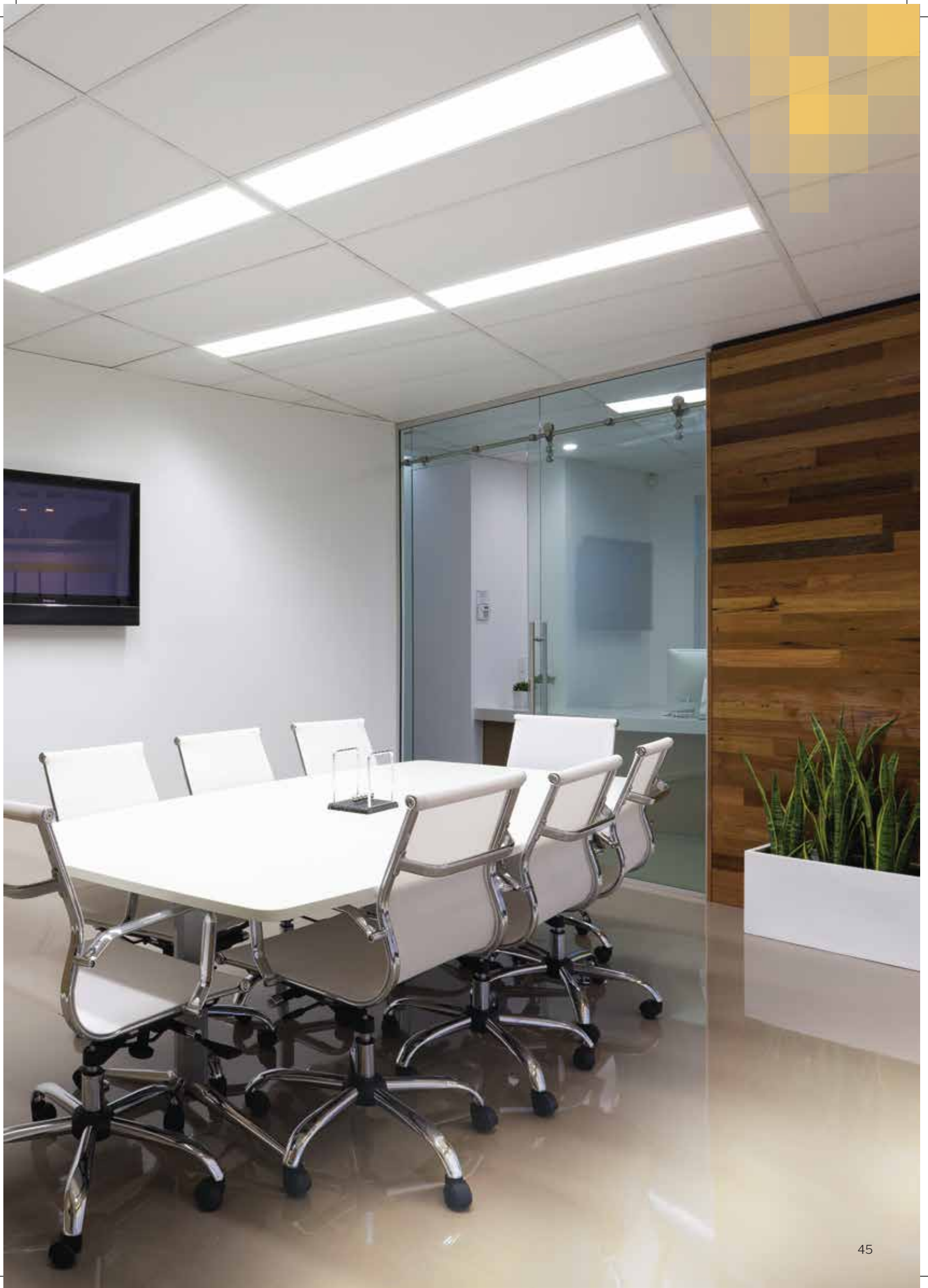

TECHZONE

SLENDO TECH

25W

Recess mounting Techzone introduce a uniquely clean, simple lighting system offering continuous lighting solution for Armstrong Techzone system.



Efficacy
Efficacy of 90 lm/W



CRCA Housing
CRCA housing white powder coated



Wide Operating Voltage / Rated Voltage
140-270V AC /
220-240V AC/50Hz



Safe & Reliable
THD<10%,
Inbuilt Surge Protection: 2.5kV
Class-I product, IK05



Higher Life
Life: 50,000 BH @ L70B50



Operating Temperature
0°C to +45°C

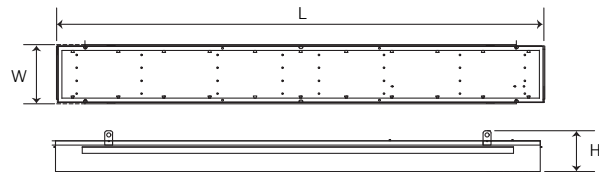

APPLICATIONS

Corporate Office

Meeting Room

Corridors

Libraries



TECHNICAL SPECIFICATION

Product Code	System Wattage (W)	LxWxH (mm)	Cutout (mm)	THD	Colour Temp. (CCT)
PTZM02254	25W	1190x145x100	1180x135	≤ 10%	4000K
PTZM02257	25W	1190x145x100	1180x135	≤ 10%	6500K

ALUMINIUM BATTEN

HARROW PLUS AL

22W

LED batten for surface and suspended applications. Aluminium housing, high transmissibility diffuser with high lumen output.



High on Efficacy

Efficacy of 130 lm/W



Aluminium Housing

Extruded aluminium housing with 0.7mm thickness



Wide Operating Voltage / Rated Voltage

140-270V AC /
220-240V AC/50Hz



Safe & Reliable

THD<10%,
Inbuilt Surge Protection: 2kV
Class-I product, IK05



Mounting System

Steel spring clamps for surface mounting



Higher Life

Life: 50,000 BH @ L70B50



Operating Temperature

0°C to +45°C

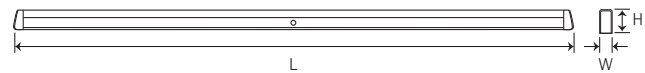

APPLICATIONS

Morden offices

Corridors & Libraries

Educational Facilities

Hospitals



TECHNICAL SPECIFICATION

Product Code	System Wattage (W)	LxWxH (mm)	Cutout (mm)	THD	Colour Temp. (CCT)
PBTM17228	22W	1170x27.5x32	—	≤ 10%	5700K

ALUMINIUM BATTEN

HARROW AL

20W*/36W

LED batten for surface and suspended applications. Aluminium housing, high transmissibility diffuser with high lumen output.

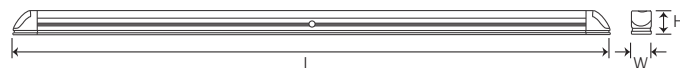

High on Efficacy

Efficacy of 110 lm/W



Aluminium Housing

With high transmittance diffuser



Wide Operating Voltage / Rated Voltage

140-270V AC /
220-240V AC/50Hz

*



Safe & Reliable

THD < 25% & < 15%
Inbuilt Surge Protection: 2KV
Class-I product, IK05



Mounting System

Steel spring clamps for surface mounting



Higher Life

Life: 50,000 BH @ L70B50



Operating Temperature

0°C to +45°C

APPLICATIONS

Morden offices

Corridors & Libraries

Educational Facilities

Hospitals



TECHNICAL SPECIFICATION

Product Code	System Wattage (W)	LxWxH (mm)	Cutout (mm)	THD	Colour Temp. (CCT)
PBTM08204	20W	1185x20x32	—	≤ 25%	4000K
PBTM08208	20W	1185x20x32	—	≤ 25%	5700K
PBTM08364	36W	1175x30x36	—	≤ 15%	4000K
PBTM08368	36W	1175x30x36	—	≤ 15%	5700K

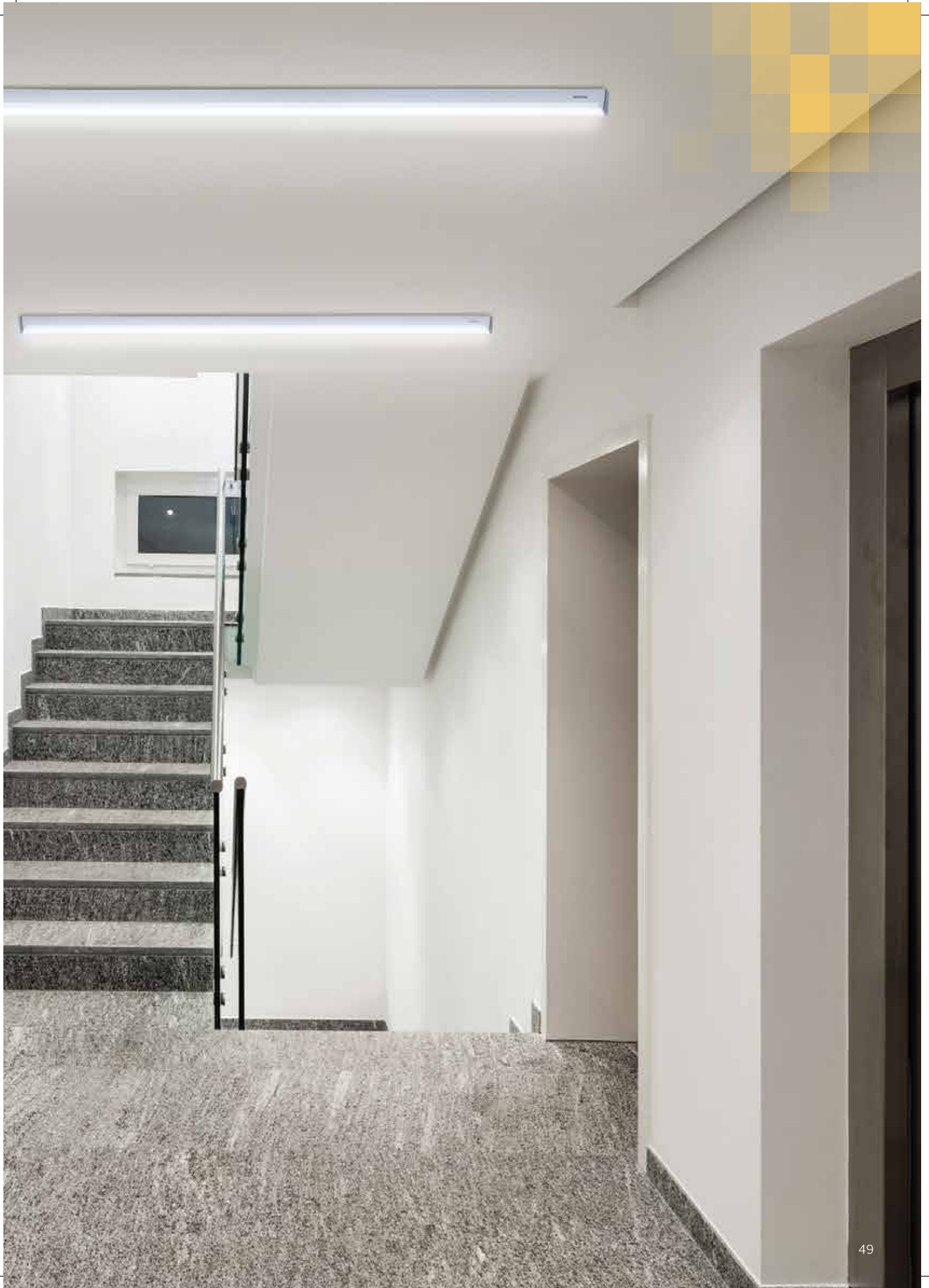

FLEXIBLE LED STRIP - IP 20

LED STRIP

12W/mtr

Flexible LED Strip Light in 5 mtrs length with 12W/mtr power consumption available with wide viewing angle of 120° offers IP20 protection and is equipped with separate energy efficient isolated electronic driver for safe operation.



Weather Proof
IP20 Protection



Non Integrated Isolated Driver
No Electric Shocks. Protects the output / secondary side from any disturbance on the Input / Primary side ensuring safe operation



Wide Operating Voltage / Rated Voltage
170-300V AC /
220-240V AC/50Hz
LED Driver Code PSLOS6003



Safe & Reliable
High Surge Protection: 4KV inbuilt



Long Life
Specially designed thermal management for long life of 50,000 BH



Operating Temperature
-10°C to +45°C

APPLICATIONS

Corporate Offices

Residences

Shopping Malls

Hotels

Retail Stores



TECHNICAL SPECIFICATION

Product Code	System Wattage (W)	LxWxH (mm)	Cutout (mm)	Colour Temp. (CCT)
PSLM06602	12W/mtr	5000x8x1.6	—	2700K
PSLM06604	12W/mtr	5000x8x1.6	—	4000K
PSLM06608	12W/mtr	5000x8x1.6	—	5700K



FLEXIBLE LED STRIP - IP 65

LED STRIP

12W/mtr

Flexible LED Strip Light in 5 mtrs length with 12W/mtr power consumption available with wide viewing angle of 120° offers IP65 protection and is equipped with separate energy efficient isolated electronic driver for safe operation.



Weather Proof
IP65 Protection



Non Integrated Isolated Driver
No Electric Shocks. Protects the output / secondary side from any disturbance on the Input / Primary side ensuring safe operation



Wide Operating Voltage / Rated Voltage
170-300V AC /
220-240V AC/50Hz
LED Driver Code PSLOS6003



Safe & Reliable
High Surge Protection: 4KV inbuilt



Long Life
Specially designed thermal management for long life of 50,000 BH



Operating Temperature
-10°C to +45°C

APPLICATIONS

Corporate Offices

Residences

Shopping Malls

Hotels

Retail Stores



TECHNICAL SPECIFICATION

Product Code	System Wattage (W)	LxWxH (mm)	Cutout (mm)	Colour Temp. (CCT)
PSLM07602	12W/mtr	5000x8x1.6	—	2700K
PSLM07604	12W/mtr	5000x8x1.6	—	4000K
PSLM07608	12W/mtr	5000x8x1.6	—	5700K

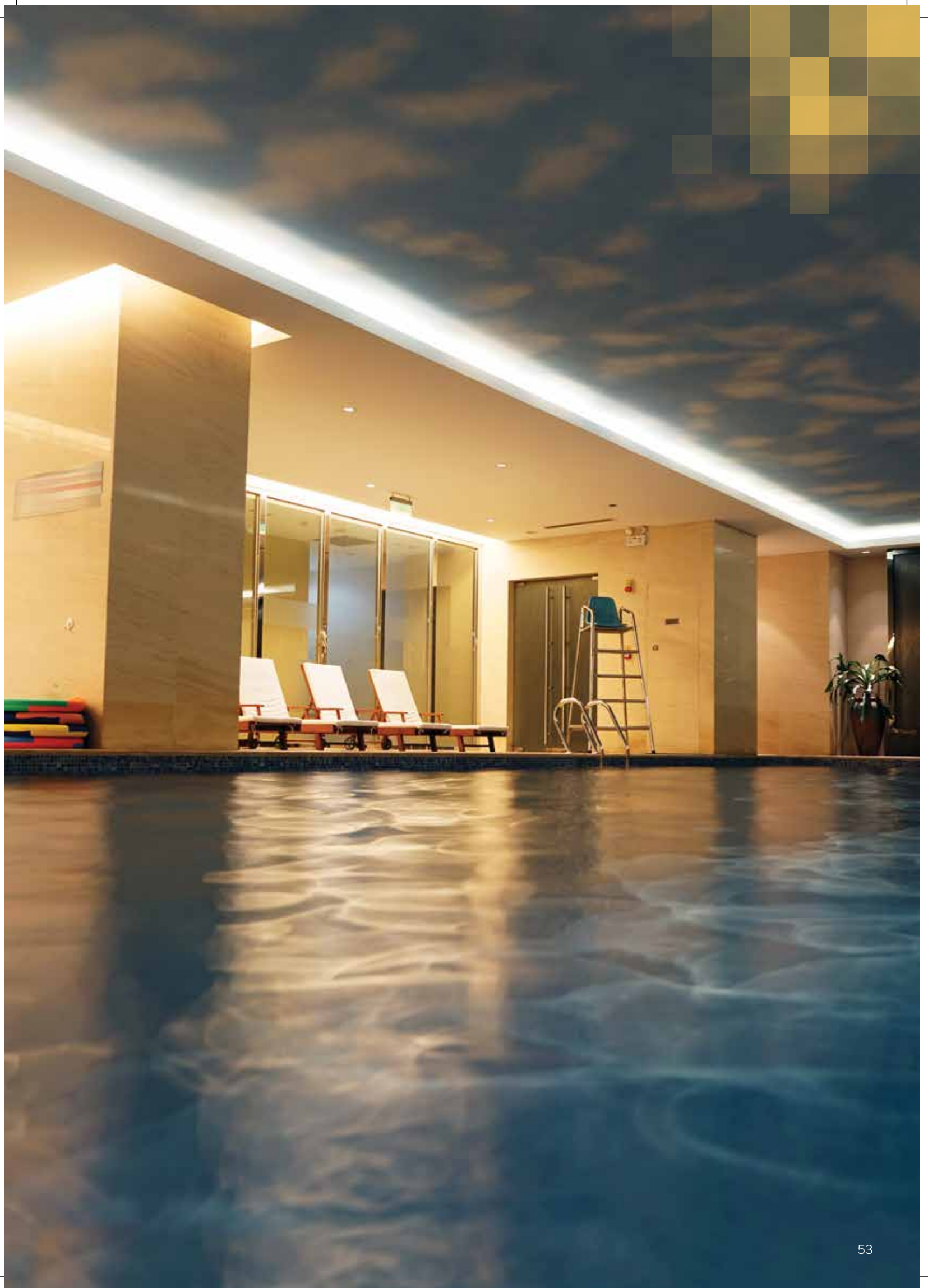

INDUSTRIAL LIGHTING

ENHANCE PRODUCTIVITY WITH
SUSTAINABLE AND SMART INFRASTRUCTURE

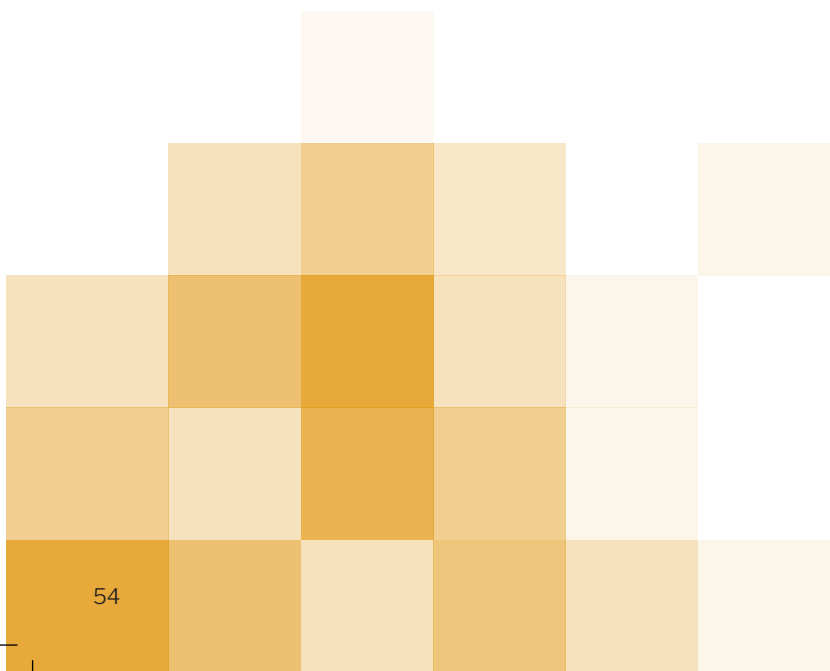



Panasonic



Industrial lighting is not just about lighting production lines, machinery and stocks; it is also about providing light for the people that need it to do their work effectively. Having the latest equipment, high-tech facilities and necessary signage in place is not enough if they cannot be seen, and the wrong color temperature or intensity in areas that require precision can reduce productivity. Getting the lux levels right on surfaces that need to be seen clearly, while at the same time reducing energy consumption is a necessity – especially in large-scale projects. Furthermore, smart lighting can be used to reduce lighting where and when it is not needed. Good industrial lighting can make daily work easier, safer and more productive.

Lighting is a critical aspect in a number of industries such as manufacturing, mining, Petrochemical, packaging, and even warehouse. Electrical fixtures for such industries are designed for heavy-duty performance and can last even in the most adverse conditions such as extreme temperatures and climate.

These industrial lighting fixtures are specially designed to meet the lighting needs and requirements of commercial areas while considering the environment and luminosity needs of the workspace. They are typically heavy-duty, well-constructed, and designed to meet the demands of the environments they are placed in.

The safety of you and your workers is especially important when handling various types of machinery and equipment. And, if the facility you work in isn't properly lit throughout every section, serious injuries, or even death, can occur. That's why Industrial Lighting makes it easier to keep their building and occupants safe.

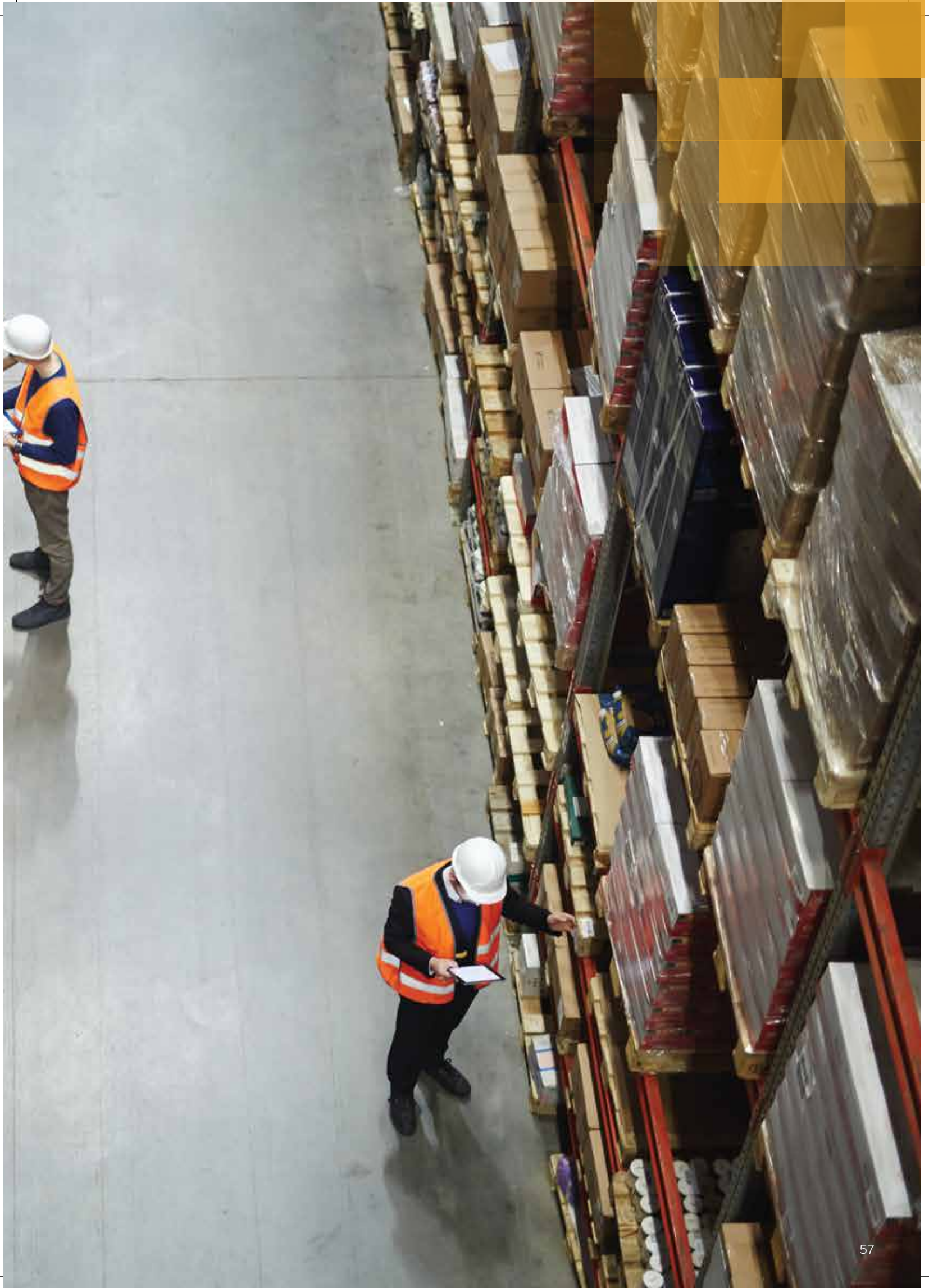

Industrial lighting requires a different approach to lighting spaces. High and low-bay downlighting along with powerful heavy-duty linear lights are low-maintenance and energy-saving lighting solutions. The correct lighting in a working area will improve visibility in the workspace, help eliminate scenarios where employees accidentally injure themselves and help present the facility in a clean and professional manner.



OPTICS

Even with the most powerful and efficient LEDs, it is not possible to get efficient results without optics. Optics provides the control that helps achieve the right lighting levels in the right places. They can reduce wasted light, glare and most importantly the number of other components needed, such as LEDs. Different beam angles are required to illuminate spaces evenly from different heights, and asymmetric light distribution can be used to focus the main part of the light exactly where required; on shelves or aisles for example. Mixing different optics in one luminaire can also make fixtures suitable for multiple purposes. In the end, optics provide clear savings when used together with efficient LEDs.

OUR OFFERING

**TECHNOLOGY AND
INNOVATION**



**GUARANTEE FOR
DEVELOPMENT
AND PRODUCTION OF
HIGH QUALITY PRODUCTS**

**UNCOMPROMISED
QUALITY OF
MATERIAL**



**UNIFORM
BRIGHTNESS**

**GREATER SAVINGS
AND OPTIMIZATION**



**SAFETY ENVIRONMENT
FOR MINIMAL RISK**

**MAINTENANCE
FREE**





WAREHOUSE LIGHTING

Warehouse lighting requires a different approach to lighting spaces. High and low-bay down lighting along with powerful heavy-duty linear lights are low-maintenance and energy-saving lighting solutions. The correct lighting in a warehouse will improve visibility in the workspace, help eliminate scenarios where employees accidentally injure themselves, and help present the facility in a clean and professional manner.

Ambience. Control. Productivity.

- Understand the lighting requirements.
- Perfect lighting that helps you to read labels and improve their accuracy.
- Understand the layout of warehouse.
- High, fully stocked aisles of goods may require aisle lighting while low shelving may be able to utilize general space lighting.
- No damaged goods & workplace accidents because of uniform glarefree lighting which increase the productivity.
- Lighting controls and sensors to turn lights on and off as necessary to minimize energy consumption.



E-commerce

A major driver of technological innovation in warehousing

E-commerce warehousing is highly competitive on account of its high-volume quick delivery nature and accordingly all variables that impact efficiency are extremely critical. Technology enables immense time and labor efficiency which in turn brings in cost efficiency. It is, therefore, no surprise that the e-commerce sector seeks increased intervention of technology in its operations, including in warehousing, which eventually drives further innovation in technology all in the continual pursuit of increased efficiency.

Globally, e-commerce has caused a wave of technological innovation in warehousing. It started with Warehouse Management Software (WMS) that reduced the burden of data entry and paper records, to conveyor belts and pick-to-light systems that helped increase the speed of sorting and picking. Smart warehouses, like smartphones, have become common parlance. Also referred to as intelligent warehouses or warehouses that think, all gadgets and devices within a smart warehouse are connected to each other via the internet and can effectively perform multiple operations simultaneously.

Another trending feature in global e-commerce warehouses is the Internet of Things (IoT). IoT is a system that connects and integrates electronic devices via the internet such that they can send and receive data from each other and perform their respective function in sync with one another.

The quest for innovation is ongoing and new technologies continue to enter warehouses.



HIGH-BAY LIGHTS



As their name implies, high-bay lights are used to illuminate spaces with high ceilings. That usually means ceilings ranging from 20 feet to approximately 45 feet. Low-bay lights, on the other hand, are used for ceilings 20 feet and under. Because a high-ceiling location has more space to fill, a high-bay by definition is a powerful light source that can brighten up a large area.

One of the benefits of high-bay lighting is that it provides clear, uniform lighting of what's below it with little glare. Different kinds of reflectors can accomplish different kinds of illumination tasks for high-bay lights. Aluminum reflectors make light from the fixtures flow directly down to the floor, while prismatic reflectors create a more diffused lighting useful for illuminating shelves and other elevated objects in space.

LED BATTEN LIGHTS



Industrial LED batten lights are extremely durable lighting solutions that are perfect for industrial and commercial environments such as warehouses, factories and stores. They are very hard wearing and are suitable for both outdoor and indoor use.

What's more, they offer the fantastic, powerful illumination that is essential for working environments and all at an exceptionally low-cost thanks to the low energy consumption of LED lighting. If you are searching for the perfect lighting solution for your industrial or commercial environment, then look no further.

WELL GLASS LIGHTS



For the hazardous environment of Oil and Gas industry, safe lighting solution is very significant. Lighting solution in this industry requires lights and luminaires that absorb heat and pressure from flammable vapours, gases, and chemical compounds.

CLEANROOM LIGHTS



Hospitals, laboratories and production environments like the food industry require lighting solutions that offer pure light, are easy to clean, dust-free and leave no room for errors. With the latest Cleanroom LED lighting, it has become easy for such operational facilities to provide the right light to the employees. We at Wipro Lighting are among the top cleanroom manufacturers that offer a wide range of energy-efficient Cleanroom LED luminaires.

Clean Room Lighting solutions use high efficacy LEDs that save energy up to 55% and reduce the operational cost significantly. The self-aligning mounting mechanism in each LED Clean Room Light Fixture ensures precision and faster installation. In addition, the specially designed pressure plates provide positive locking, dust, and water-proofing. Finally, the driver of each LED Clean Room Light Fixture is designed keeping in mind the Indian power conditions, thus incredibly resourceful.

LED CIRCULAR BAYLIGHT

ENVISO PRO

80W/100W/120W/150W/180W

Aesthetically designed robust LED high bay equipped with specially designed heat sink and reliable integrated energy efficient driver to meet the different requirement across Industrial application.



High on Efficacy

Efficacy: upto 150lm/W



Robust Design

Innovative, aesthetic and robust design
UV stabilized IP PC Lens for better light distribution.



Wide Operating Voltage / Rated Voltage

140-270V AC /
220-240V AC/50Hz



Safe & Reliable

High Surge Protection: 4kV
10kV Optional Surge Protection



High Performance Electronic Driver

Potted driver for better thermal reliability,
easy maintenance



Higher Life

Life: 50,000 BH @ L70B50



Operating Temperature

-10°C to +50°C

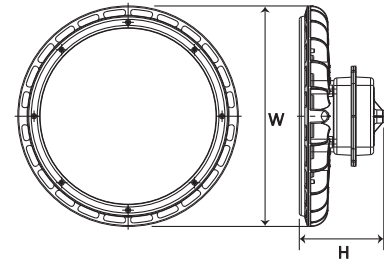

APPLICATIONS

Factories & Assembly Line

Cement & Steel Plants

Medium Industrial Units

Toll Plaza

Warehouse



TECHNICAL SPECIFICATION

Product Code	System Wattage (W)	DiaxH (mm)	Cutout (mm)	THD	Colour Temp. (CCT)	Weight (kg)
PBYM14808 / PBYM15808	80W	245x185	—	≤ 10%	5700K	2.5
PBYM14AB8 / PBYM15AB8	100W	245x185	—	≤ 10%	5700K	2.5
PBYM14CD8 / PBYM15CD8	120W	340x175	—	≤ 10%	5700K	3.7
PBYM14FG8 / PBYM15FG8	150W	340x175	—	≤ 10%	5700K	3.7
PBYM14KL8 / PBYM15KL8	180W	340x175	—	≤ 10%	5700K	3.7

PBYM14** - 60°, PBYM15** - 90°

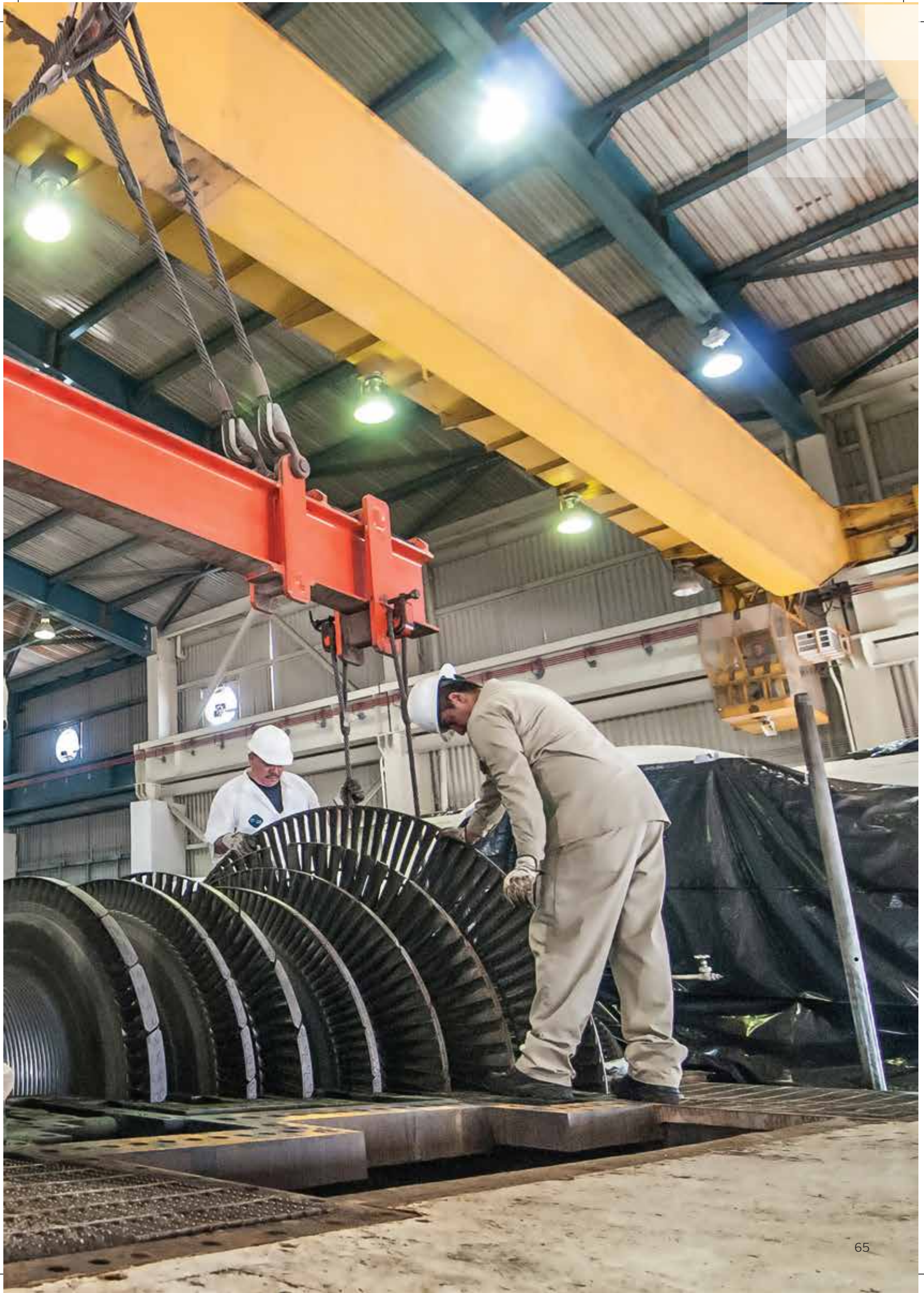

LED CIRCULAR BAYLIGHT

ENVISO

60W

Aesthetically designed robust LED high bay equipped with specially designed heat sink and reliable integrated energy efficient driver to meet the different requirement across Industrial application.



High on Efficacy

Efficacy > 125lm/W



Robust Design

Innovative, aesthetic and robust design with pressure die cast aluminum housing with heat resistant toughened glass with PC Lens for better light distribution.



Wide Operating Voltage / Rated Voltage

140-270V AC /
220-240V AC/50Hz



Safe & Reliable

High Surge Protection: 6kV
10kV Optional Surge Protection



High Performance Electronic Driver

Potted driver for better thermal reliability,
easy maintenance



Higher Life

Life: 50,000 BH @ L70B50



Operating Temperature

0°C to +50°C

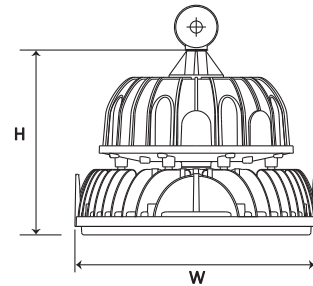

APPLICATIONS

Factories & Assembly Line

Cement & Steel Plants

Medium Industrial Units

Toll Plaza

Warehouse



TECHNICAL SPECIFICATION

Product Code	System Wattage (W)	DiaxH (mm)	Cutout (mm)	THD	Colour Temp. (CCT)	Weight (kg)
PBYM11608	60W	200x162	—	≤ 10%	5700K	1.9
PBYM12608*	60W	200x162	—	≤ 10%	5700K	1.9

PBYM11** - 60°, PBYM12** - 90°

LED CIRCULAR BAYLIGHT

ENVISO

80W/100W/120W

Aesthetically designed robust LED high bay equipped with specially designed heat sink and reliable integrated energy efficient driver to meet the different requirement across Industrial application.



High on Efficacy

Efficacy $\geq 125\text{lm/W}$



Robust Design

Innovative, aesthetic and robust design with pressure die cast aluminum housing and UV stabilized IP PC Lens for better light distribution.



Wide Operating Voltage / Rated Voltage

140-270V AC /
220-240V AC/50Hz



Safe & Reliable

High Surge Protection: 6kV
10kV Optional Surge Protection



High Performance Electronic Driver

Potted driver for better thermal reliability,
easy maintenance



Higher Life

Life: 50,000 BH @ L70B50



Operating Temperature

0°C to +50°C

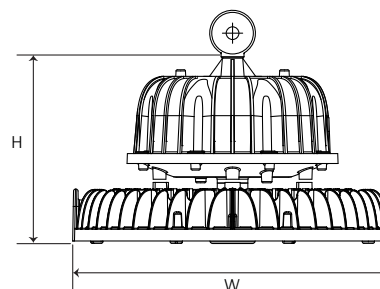

APPLICATIONS

Factories & Assembly Line

Cement & Steel Plants

Medium Industrial Units

Toll Plaza

Warehouse



TECHNICAL SPECIFICATION

Product Code	System Wattage (W)	DiaxH (mm)	Cutout (mm)	THD	Colour Temp. (CCT)	Weight (kg)
PBYM11808 / PBYM12808	80W	252x155	—	$\leq 10\%$	5700K	2.4
PBYM11AB8 / PBYM12AB8	100W	252x155	—	$\leq 10\%$	5700K	2.4
PBYM11CD8 / PBYM12CD8	120W	252x155	—	$\leq 10\%$	5700K	2.4

PBYM11** - 60°, PBYM12** - 90°

LED CIRCULAR BAYLIGHT

ENVISO

150W/180W

Aesthetically designed robust LED high bay equipped with specially designed heat sink and reliable integrated energy efficient driver to meet the different requirement across Industrial application.



High on Efficacy

Efficacy > 120lm/W for 150W,
140lm/W for 180W,



Robust Design

Innovative, aesthetic and robust design with pressure die cast aluminum housing



Wide Operating Voltage / Rated Voltage

140-270V AC /
220-240V AC/50Hz



Safe & Reliable

High Surge Protection: 6kV
10kV Optional Surge Protection



High Performance Electronic Driver

Potted driver for better thermal reliability,
easy maintenance



Higher Life

Life: 50,000 BH @ L70B50



Operating Temperature

0°C to +50°C

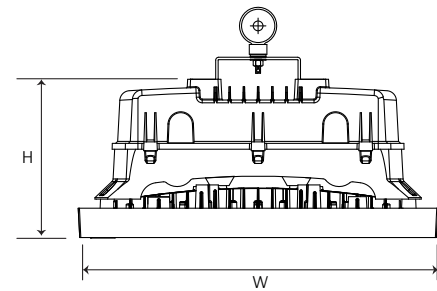

APPLICATIONS

Factories & Assembly Line

Cement & Steel Plants

Medium Industrial Units

Toll Plaza

Warehouse



TECHNICAL SPECIFICATION

Product Code	System Wattage (W)	Diaph (mm)	Cutout (mm)	THD	Colour Temp. (CCT)	Weight (kg)
PBYM11FG8 / PBYM12FG8	150W	298x156	—	≤ 10%	5700K	3.8
PBYM11KL8 / PBYM12KL8	180W	368x162	—	≤ 10%	5700K	5.5

PBYM11** - 60°, PBYM12** - 90°

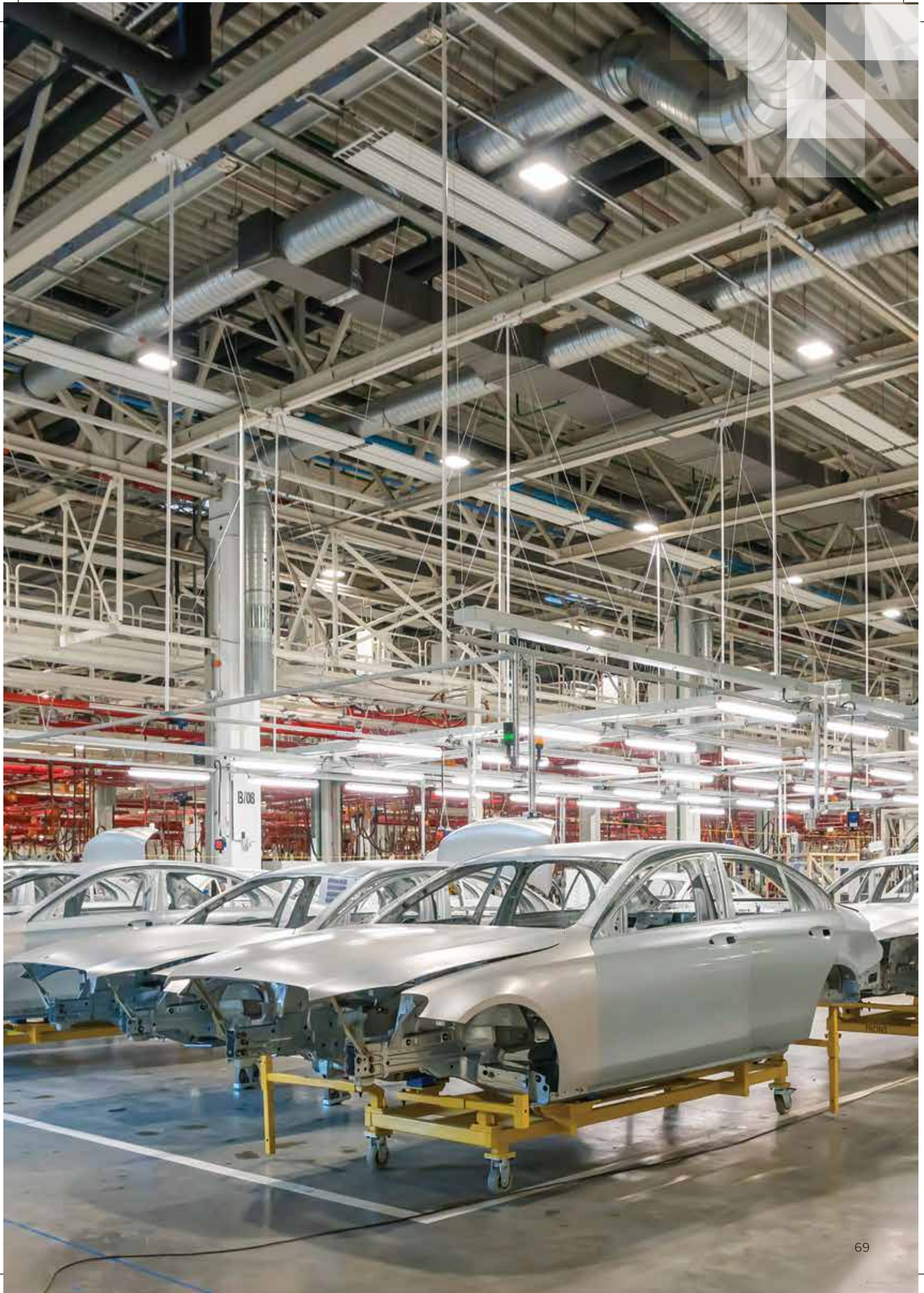

INDUSTRIAL BATTEN - IP20

HARROW

20W/40W

LED batten for surface and suspended application. White powder coated CRCA housing with LEDs. Seamless front frame is with white high transmission acrylic cover and decorative end cap.



High on Efficacy

Efficacy: 120lm/W for 20W and 115lm/W for 40W



Robust Design

White powder coated CRCA housing with LEDs and seamless front frame



Wide Operating Voltage / Rated Voltage

140-270V AC / 220-240V AC/50Hz



Safe & Reliable

High Surge Protection: 4kV



High Performance Electronic Driver

Non-integrated energy efficient electronic driver



Higher Life

Life: 50,000 BH @ L70B50



Operating Temperature

-10°C to +45°C



APPLICATIONS

Factory & Assembly Line

Warehouses

Parking Area

Battery Room

Retail Chain

Railway Platform

Chiller Plants



TECHNICAL SPECIFICATION

Product Code	System Wattage (W)	LxWxH (mm)	Cutout (mm)	THD	Colour Temp. (CCT)	Weight (kg)
PBTM12204	20W	1185x43x62	—	≤ 10%	4000K	1.25
PBTM12208	20W	1185x43x62	—	≤ 10%	5700K	1.25
PBTM12404	40W	1185x43x62	—	≤ 10%	4000K	1.25
PBTM12408	40W	1185x43x62	—	≤ 10%	5700K	1.25

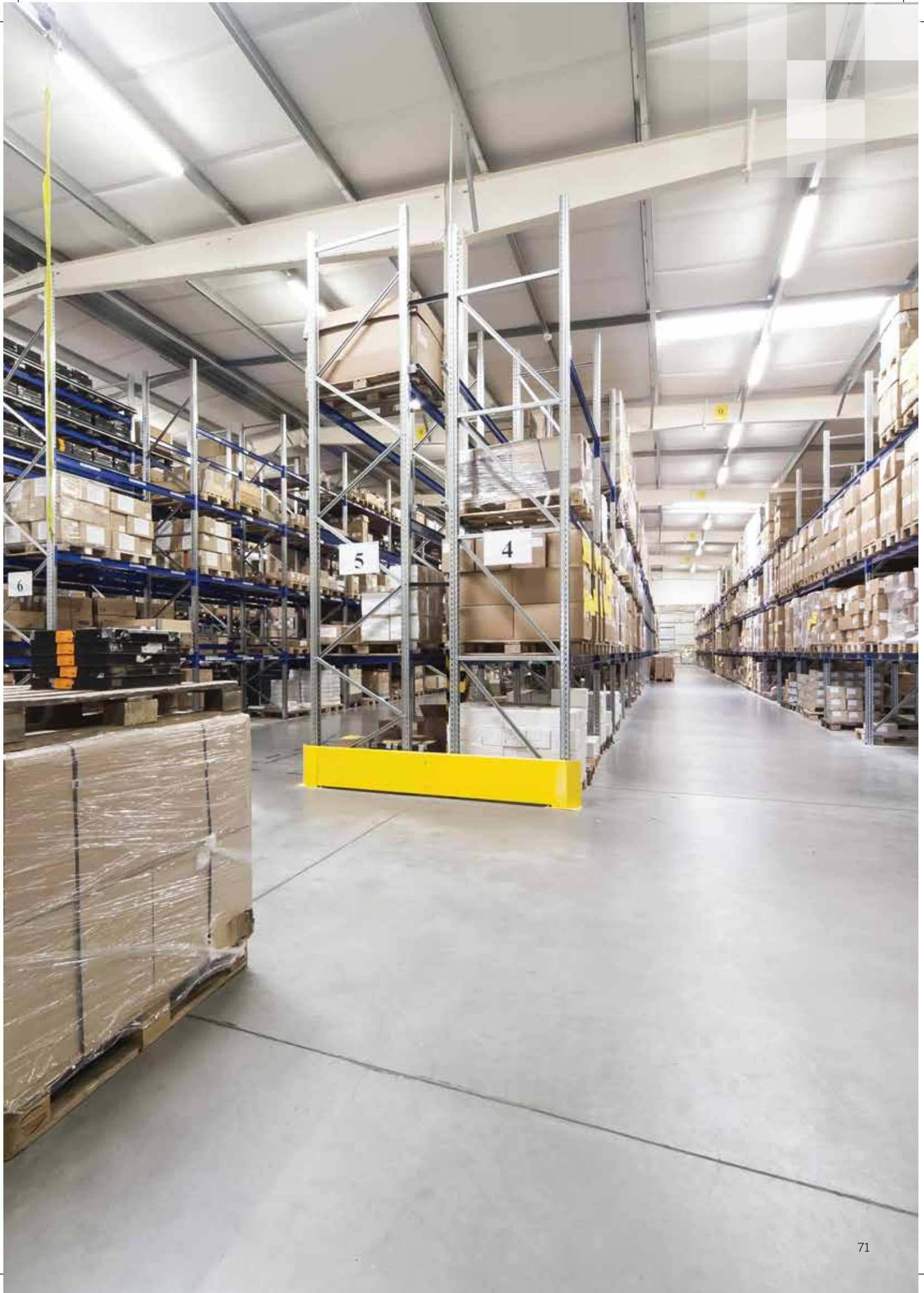

INDUSTRIAL BATTEN

TRUSS ADV

20W/40W

LED Batten with inbuilt heat sink, polycarbonate housing equipped with anti-glare diffuser & energy efficient electronics driver



High on Efficacy

Efficacy: 110lm/W



Robust Design

Polycarbonate housing equipped with anti-glare diffuser



Wide Operating Voltage / Rated Voltage

140-270V AC /
220-240V AC/50Hz



Safe & Reliable

High Surge Protection: 4kV



High Performance Electronic Driver

Integrated energy efficient electronic driver



Higher Life

Life: 50,000 BH @ L70B50



Operating Temperature

-10°C to +45°C

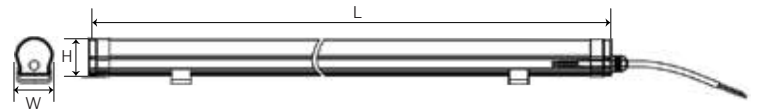

APPLICATIONS

Factory & Assembly Line

Warehouses

Parking Area

Battery Room

Railway Platform

Chiller Plants



TECHNICAL SPECIFICATION

Product Code	System Wattage (W)	LxWxH (mm)	Cutout (mm)	THD	Colour Temp. (CCT)	Weight (kg)
PBTM19204	20W	1200x44.6x44.6	—	≤ 10%	4000K	1.0
PBTM19208	20W	1200x44.6x44.6	—	≤ 10%	5700K	1.0
PBTM19207	20W	1200x44.6x44.6	—	≤ 10%	6500K	1.0
PBTM19404	40W	1200x44.6x44.6	—	≤ 10%	4000K	1.0
PBTM19408	40W	1200x44.6x44.6	—	≤ 10%	5700K	1.0
PBTM19407	40W	1200x44.6x44.6	—	≤ 10%	6500K	1.0



INDUSTRIAL BATTEN

TRUSS

20W/40W

LED Batten with inbuilt heat sink, polycarbonate housing equipped with anti-glare diffuser & energy efficient electronics driver



High on Efficacy
Efficacy: 120lm/W



Robust Design
Polycarbonate housing equipped with anti-glare diffuser



Wide Operating Voltage / Rated Voltage
140-270V AC /
220-240V AC/50Hz



Safe & Reliable
High Surge Protection: 4kV
10kV Optional Surge Protection



High Performance Electronic Driver
Integrated energy efficient isolated electronic driver



Higher Life
Life: 50,000 BH @ L70B50



Operating Temperature
-10°C to +45°C

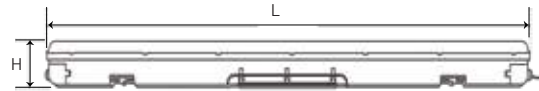

APPLICATIONS

Factory & Assembly Line
Warehouses
Parking Area
Battery Room
Railway Platform
Chiller Plants



TECHNICAL SPECIFICATION

Product Code	System Wattage (W)	LxWxH (mm)	Cutout (mm)	THD	Colour Temp. (CCT)	Weight (kg)
PBTM05204	20W	1140x75x70	—	≤ 10%	4000K	1.10
PBTM05207	20W	1140x75x70	—	≤ 10%	6500K	1.10
PBTM05404	40W	1140x75x70	—	≤ 10%	4000K	1.10
PBTM05407	40W	1140x75x70	—	≤ 10%	6500K	1.10



WELL GLASS

MERLIN PLUS

24W/35W/40W/70W

Aesthetically designed LED Wellglass equipped with specially designed heat sink and reliable energy efficient electronic isolated driver to meet different lighting requirements across industrial application.



High on Efficacy

130lm/w for clear & 120lm/w for diffused version



Impact Resistance IK08

Protected against 5 joules of impact (equivalent to the impact of a 1.7kg mass dropped from 300mm above the impacted surface)



Wide Operating Voltage / Rated Voltage

140-270V AC /
220-240V AC/50Hz



Safe & Reliable

THD<10%,
Inbuilt Surge Protection: 6kV + 10kV Optional
Class-I product, IP66



Non Integrated Isolated Driver

Protects the output/secondary side from any disturbance on the input/primary side ensuring safe operation.



Higher Life

Life: 50,000 BH @ L70B50



Operating Temperature

-10°C to +45°C

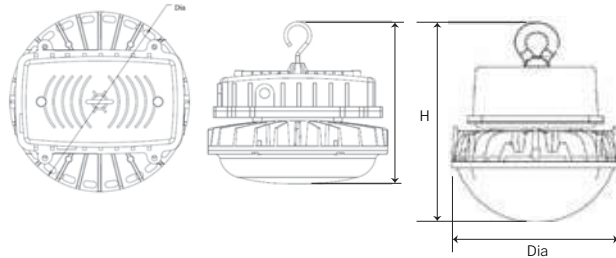

APPLICATIONS

Cement Plants

Oil Processing Factories

Coal Mines

Industrial Unit

Thermal Power Plant



TECHNICAL SPECIFICATION

Product Code	System Wattage (W)	DiaxH (mm)	Cutout (mm)	THD	Colour Temp. (CCT)	Weight (kg)
PWGM09248	24W Clear Type	146x195	—	≤10%	5700K	0.95
PWGM09358	35W Clear Type	146x195	—	≤10%	5700K	0.95
PWGM09408	40W Clear Type	146x195	—	≤10%	5700K	0.95
PWGM09708	70W Clear Type	200x181	—	≤10%	5700K	2.10
PWGM10248	24W Diffused Type	146x195	—	≤10%	5700K	0.95
PWGM10358	35W Diffused Type	146x195	—	≤10%	5700K	0.95
PWGM10408	40W Diffused Type	146x195	—	≤10%	5700K	0.95
PWGM10708	70W Diffused Type	200x181	—	≤10%	5700K	2.10

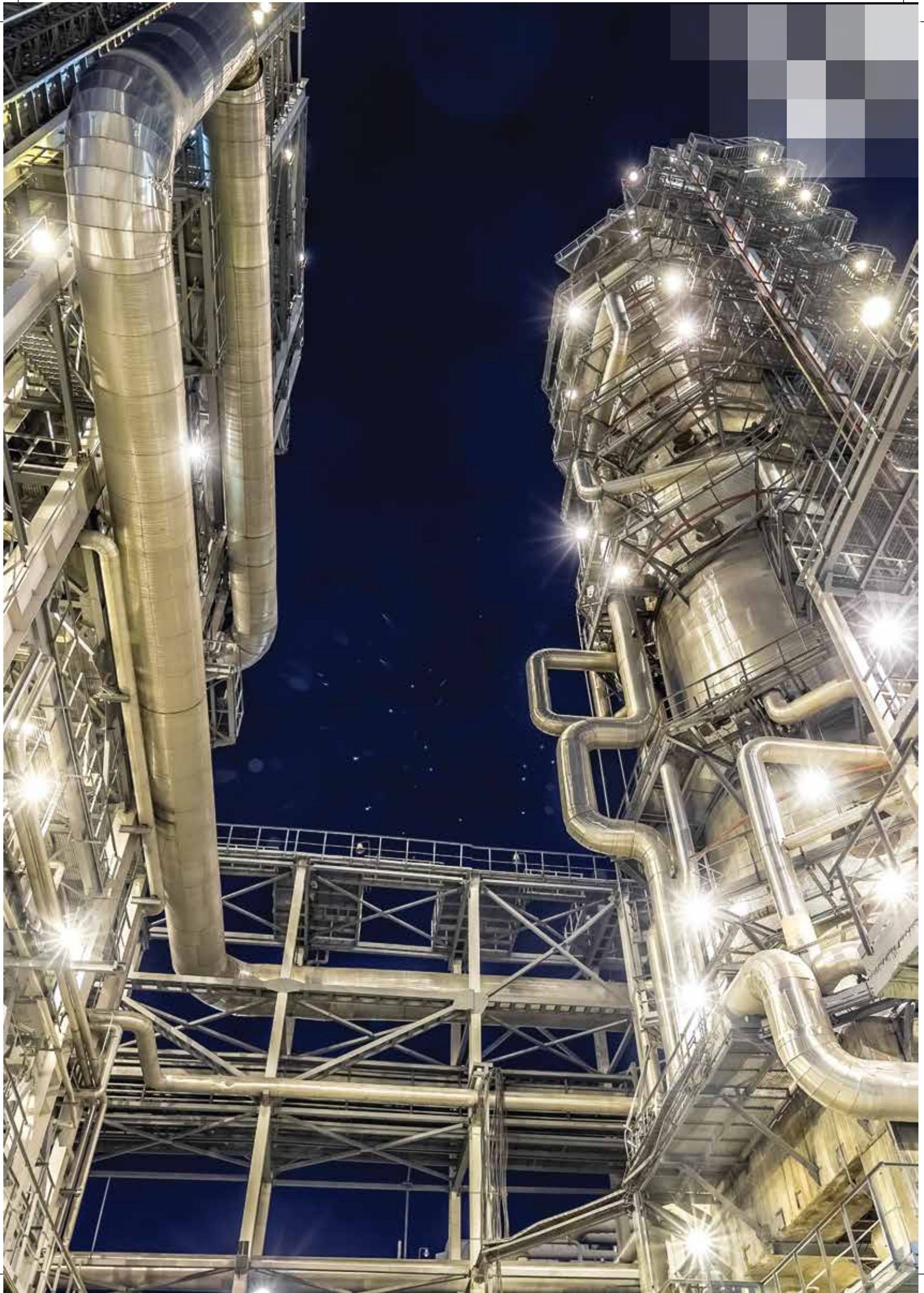

UNDER CANOPY

CANO PLUS

80W

LED Under Canopy luminaire aesthetically designed with better thermal management. Housing made of PDC and MS frame with toughened glass. This LED luminaire is designed to replace conventional under canopy applications. It is also recommended for Industrial application.



High on Efficacy
Efficacy: 115lm/W



Robust Design
PDC housing and frame with heat resistant toughened glass (LILO Optional).



Wide Operating Voltage / Rated Voltage
140-270V AC /
220-240V AC/50Hz



Safe & Reliable
High Surge Protection: 4kV
10kV Optional Surge Protection



High Performance Electronic Driver
Non-integrated energy efficient isolated electronic driver



Higher Life
Life: 50,000 BH @ L70B50



Operating Temperature
-10°C to +45°C

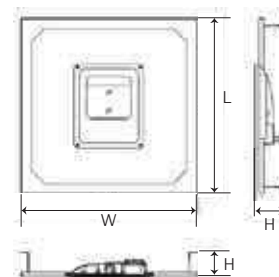

APPLICATIONS

Petrol Pumps

Gas Stations

Under Canopy Areas

Railway Stations



TECHNICAL SPECIFICATION

Product Code	System Wattage (W)	LxWxH (mm)	Cutout (mm)	THD	Colour Temp. (CCT)	Weight (kg)
PCNM02808	80W	600x600x100	595x595	≤ 10%	5700K	8.0



UNDER CANOPY

CANO PRO

80W

LED Under Canopy luminaire aesthetically designed with better thermal management. Housing made of PDC and MS frame with toughened glass. This LED luminaire is designed to replace conventional under canopy applications. It is also recommended for Industrial application.



High on Efficacy
Efficacy: 115lm/W



Robust Design
PDC housing and frame with heat resistant toughened glass (LILO Optional).



Wide Operating Voltage / Rated Voltage
140-270V AC /
220-240V AC/50Hz



Safe & Reliable
High Surge Protection: 4kV
10kV Optional Surge Protection



High Performance Electronic Driver
Non-integrated energy efficient isolated electronic driver



Higher Life
Life: 50,000 BH @ L70B50



Operating Temperature
-10°C to +45°C

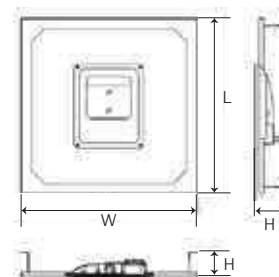

APPLICATIONS

Petrol Pumps

Gas Stations

Under Canopy Areas

Railway Stations



TECHNICAL SPECIFICATION

Product Code	System Wattage (W)	LxWxH (mm)	Cutout (mm)	THD	Colour Temp. (CCT)	Weight (kg)
PCNM03808	80W	324x305x68	-	≤10%	5700K	3.1

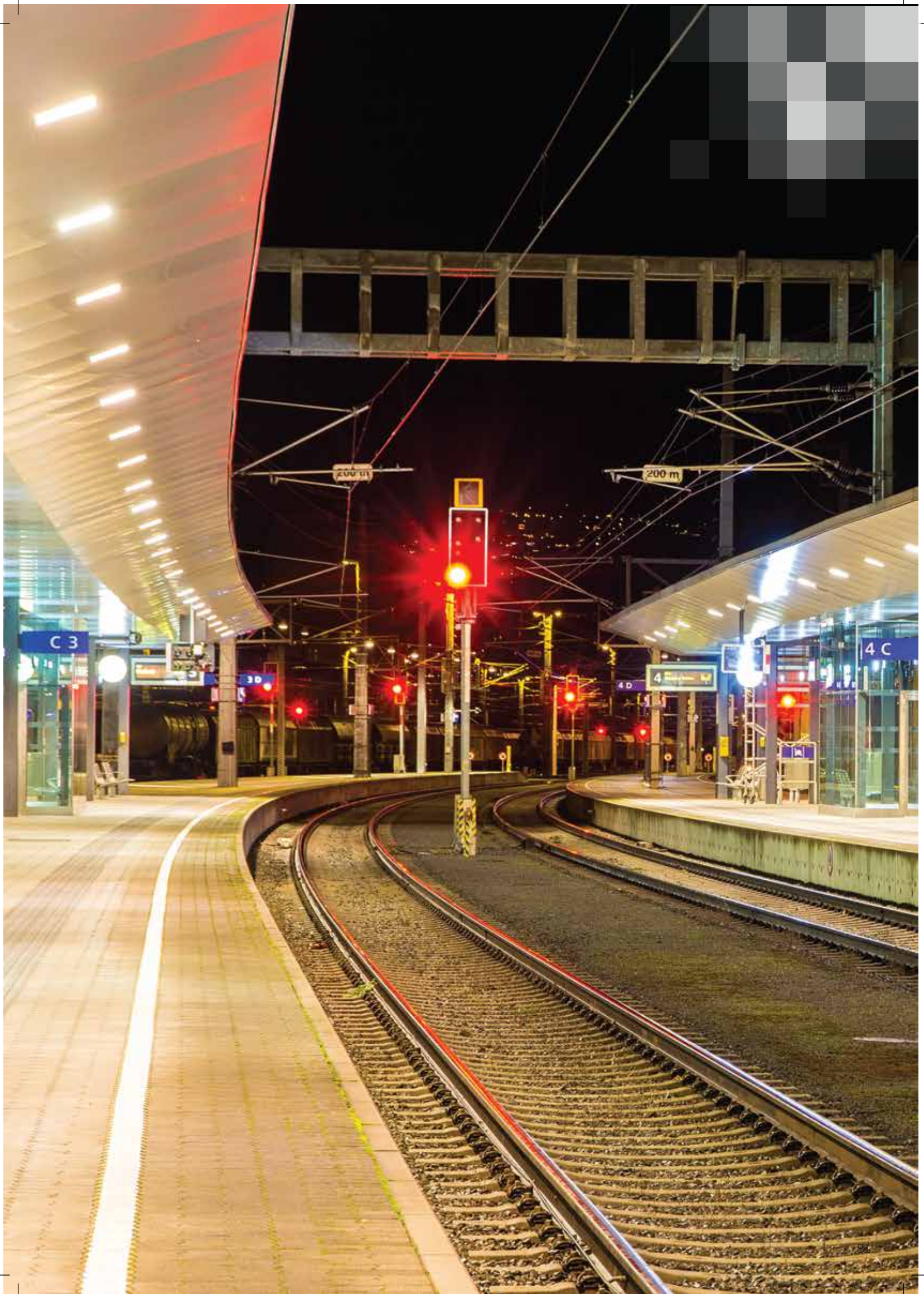

BULK HEAD

ELLIPTO

10W

Ceiling and Wall mount LED bulk head serves as an excellent energy efficient alternative to CFL/ incandescent bulkhead luminaires.



100
lm/W



Housing

Polycarbonate housing with polycarbonate diffuser for better light distribution



High Performance Electronic Driver

Non isolated integral driver with constant current



Wide Operating Voltage / Rated Voltage

140-270V AC /
220-240V AC/50Hz



Safe & Reliable

THD<10%, Inbuilt Surge Protection: 4KV
Class-II Product



Weather Proof

IP65 Protection



Higher Life

Life: 50,000 BH @ L70B50



Operating Temperature

-10°C to +45°C

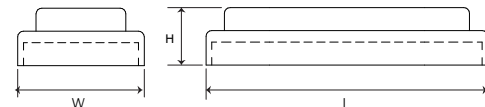

APPLICATIONS

- Lawns
- Gardens
- Pathway
- Courtyard
- Factories

120° Ra 80 IP 65 IK 09

TECHNICAL SPECIFICATION

Product Code	System Wattage (W)	LxWxH (mm)	Cutout (mm)	THD	Colour Temp. (CCT)	Weight (kg)
PBHM01107	10W	232x105x50	—	≤ 10%	6500K	0.255

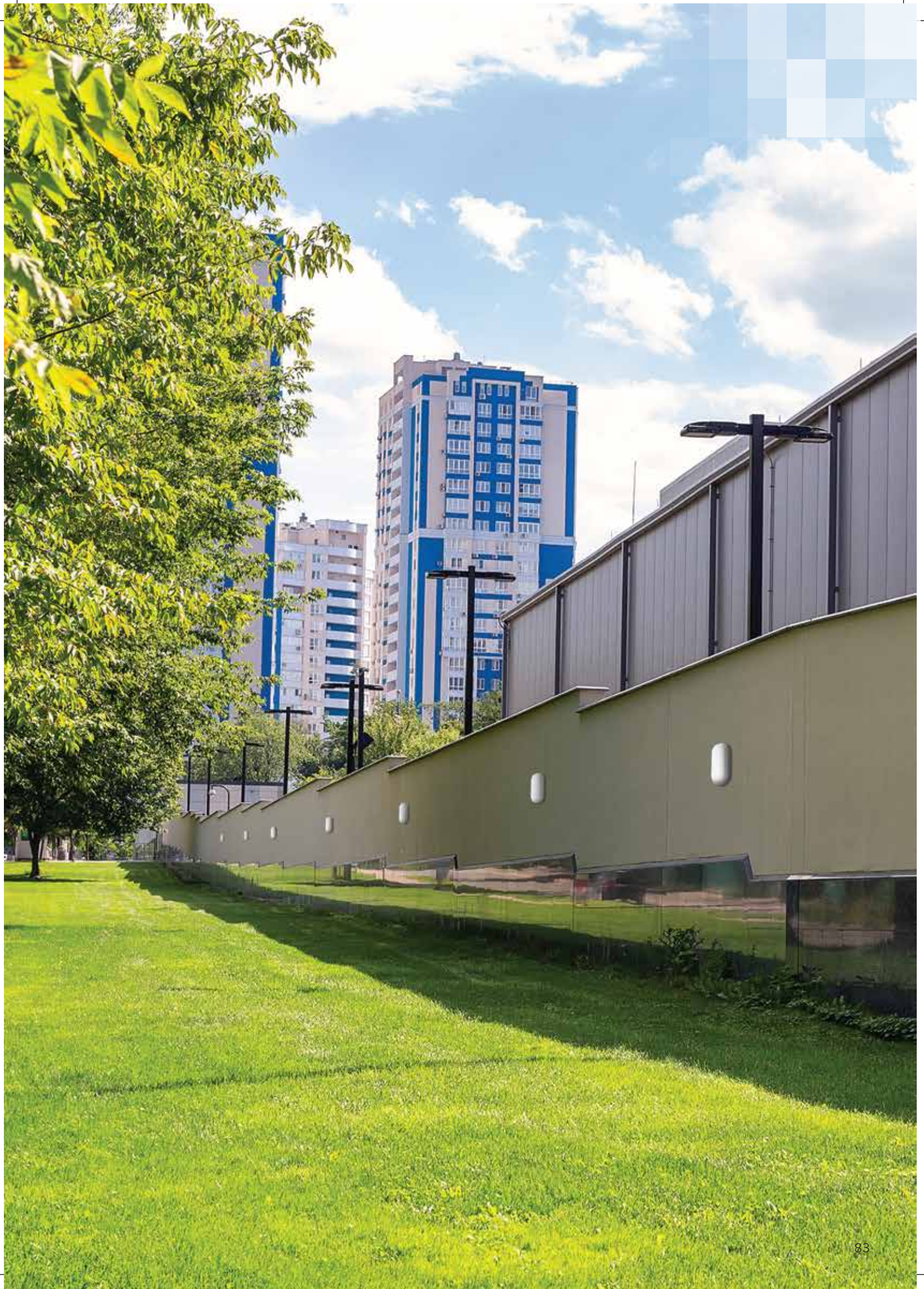

IP54 TRUNKING SYSTEM

40W

IP54 Trunking - Batten comprises of aluminium extrusion housing white powder coated, Opal polycarbonate diffuser for symmetric light distribution and non integral isolated driver for safe operations. Suitable for 3, 5 & 7 wire system.



High on Efficacy
40W with 115lm/W



Trunking
- Aluminium Extrusion Trunk with white powder coated
- Trunk dimensions- 1.5mtr 3mtr & 3.5mtr with 3, 5 & 7 wire system



Wide Operating Voltage / Rated Voltage
140-270V AC /
220-240V AC/50Hz



Safe & Reliable
THD<10%, Class-I Product, IP54,
Inbuilt Surge Protection: 4KV+10kV Optional



Non Integrated Isolated Driver
Protects the output /secondary side from any disturbance on the Input /Primary side ensuring safe operation



Higher Life
Life: 50,000 BH @ L70B50



Operating Temperature
-10°C to +45°C

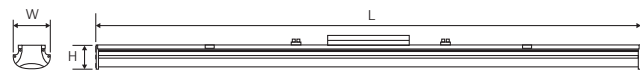

APPLICATIONS

Metros

Factories



TECHNICAL SPECIFICATION

Product Code	System Wattage (W)	LxWxH (mm)	Cutout (mm)	THD	Colour Temp. (CCT)	Weight (kg)
PTBM03408	40W	1200x82x52	—	≤ 10%	5700K	2.6
PATM03153	—	1500x56.5x50	—	—	—	2.5
PATM03155	—	1500x56.5x50	—	—	—	2.5
PATM03157	—	1500x56.5x50	—	—	—	2.5
PATM03303	—	3000x56.5x50	—	—	—	5.0
PATM03305	—	3000x56.5x50	—	—	—	5.0
PATM03307	—	3000x56.5x50	—	—	—	5.0
PATM03353	—	3500x56.5x50	—	—	—	5.8
PATM03354	—	3500x56.5x50	—	—	—	5.8
PATM03357	—	3500x56.5x50	—	—	—	5.8



CLEANROOM BOTTOM OPENING

IMBUE

18W/22W/28W/36W/45W/60W

IP 54, dust free & zero maintenance
LED clean room recess mounted with bottom opening luminaire with CRCA powder coating housing, anti glare diffuser with potentiometric integrated energy efficient electronic driver.



Potentiometric Driver

Potentiometric integrated energy efficient electronic driver for 36W & above.



High Ingress Protection

Dust and splash water protected IP54 luminaire. The diffuser is sealed with the bottom frame using non-hygroscopic VHB gasket ensuring high ingress protection



Operating Temperature

-10°C to +50°C



Safe & Reliable

THD<10%,
Inbuilt Surge Protection: 2.5kV+10kV External
Class-I product, IP54



Environment Friendly

An energy efficient lighting solution reducing the (LPD) which makes it an ideal choice for green industries



No Maintenance & Long Life

Constant Current Constant Voltage (CCCV) driver ensures maintenance free long service life of 50000 hours



Wide Operating Voltage / Rated Voltage

180-280V AC /
220-240V AC/50Hz

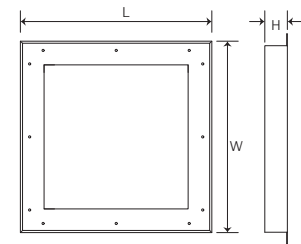

APPLICATIONS

- Pharmaceutical Industries
- Chemical & Biological Lab
- Semiconductor Fabrication
- Food & Beverage Industries
- Hospital



TECHNICAL SPECIFICATION

Product Code	System Wattage (W)	LxWxH (mm)	Cutout (mm)	THD	Colour Temp. (CCT)	Weight (kg)
PCRM03184	18W (Screw & MS Bottom Frame)	300x300x65	270x270	≤ 10%	4000K	2.0
PCRM03188	18W (Screw & MS Bottom Frame)	300x300x65	270x270	≤ 10%	5700K	2.0
PCRM03224	22W (Screw & MS Bottom Frame)	300x300x65	270x270	≤ 10%	4000K	2.0
PCRM03228	22W (Screw & MS Bottom Frame)	300x300x65	270x270	≤ 10%	5700K	2.0
PCRM03284	28W (Screw & MS Bottom Frame)	300x300x65	270x270	≤ 10%	4000K	2.0
PCRM03288	28W (Screw & MS Bottom Frame)	300x300x65	270x270	≤ 10%	5700K	2.0
PCRM03364	36W (Screw & MS Bottom Frame)	600x600x65	570x570	≤ 10%	4000K	6.2
PCRM03368	36W (Screw & MS Bottom Frame)	600x600x65	570x570	≤ 10%	5700K	6.2
PCRM03454	45W (Screw & MS Bottom Frame)	600x600x65	570x570	≤ 10%	4000K	6.2
PCRM03458	45W (Screw & MS Bottom Frame)	600x600x65	570x570	≤ 10%	5700K	6.2
PCRM03604	60W (Screw & MS Bottom Frame)	600x600x65	570x570	≤ 10%	4000K	6.2
PCRM03608	60W (Screw & MS Bottom Frame)	600x600x65	570x570	≤ 10%	5700K	6.2

* Also available in MS Frame without Screw, SS Frame with Screw and SS Frame without Screw options.t

CLEANROOM TOP OPENING

IMBUE

45W/60W

IP 54, dust free & zero maintenance LED
Clean Room Top opening luminaire with
CRCA powder coating housing, anti glare
diffuser with potentiometric integrated
energy efficient electronic driver.

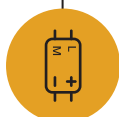

Potentiometric Driver

Potentiometric integrated energy efficient electronic driver for 36W & above.



High Ingress Protection

Dust and splash water protected IP54 luminaire. The diffuser is sealed with the bottom frame using non-hygroscopic VHB gasket ensuring high ingress protection



Operating Temperature

-10°C to +50°C



Safe & Reliable

THD<10%, Inbuilt Surge Protection: 2.5kV+10kV Optional Class-I product, IP54



Environment Friendly

An energy efficient lighting solution reducing the (LPD) which makes it an ideal choice for green industries



No Maintenance & Long Life

Constant Current Constant Voltage (CCCV) driver ensures maintenance free long service life of 50000 hours



Wide Operating Voltage / Rated Voltage

180-280V AC /
220-240V AC/50Hz

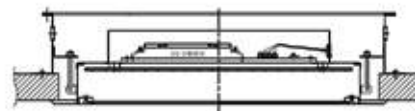

APPLICATIONS

Pharmaceutical Industries
Chemical & Biological Lab
Semiconductor Fabrication
Food & Beverage Industries
Hospital



TECHNICAL SPECIFICATION

Product Code	System Wattage (W)	LxWxH (mm)	Cutout (mm)	THD	Colour Temp. (CCT)	Weight (kg)
PCRM07454	45W (MS Frame)	650x650x75	580x580	≤ 10%	4000K	7.2
PCRM07458	45W (SS Frame)	650x650x75	580x580	≤ 10%	5700K	7.2
PCRM07604	60W (MS Frame)	650x650x75	580x580	≤ 10%	4000K	7.2
PCRM07608	60W (SS Frame)	650x650x75	580x580	≤ 10%	5700K	7.2
PCRM08454	45W (MS Frame)	650x650x75	580x580	≤ 10%	4000K	7.2
PCRM08458	45W (SS Frame)	650x650x75	580x580	≤ 10%	5700K	7.2
PCRM08604	60W (MS Frame)	650x650x75	580x580	≤ 10%	4000K	7.2
PCRM08608	60W (SS Frame)	650x650x75	580x580	≤ 10%	5700K	7.2

Walkable Hump PCHM01000





STREET LIGHTING

SUPERIOR ILLUMINATION
PERFORMANCE & FLEXIBILITY YOU NEED.

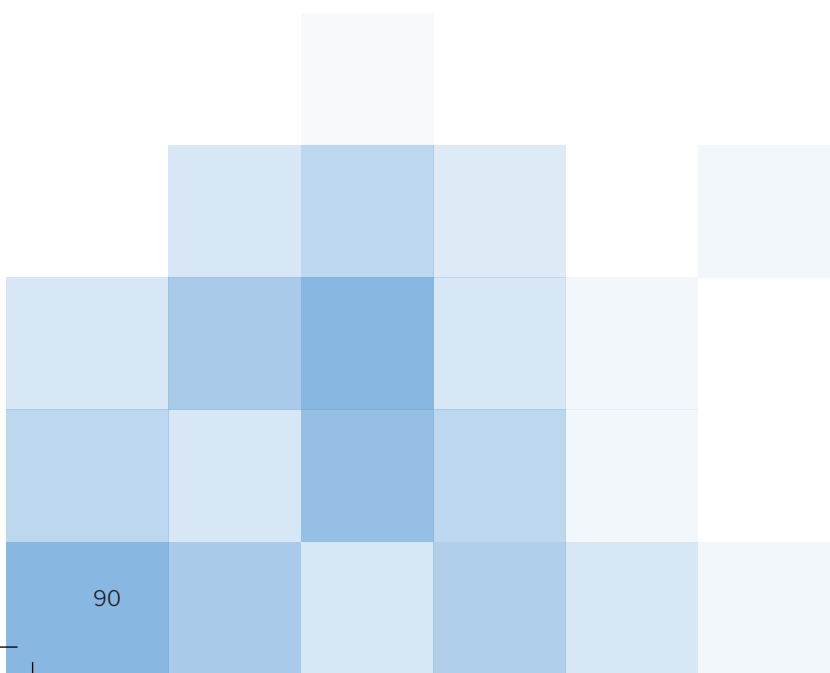



STREET LIGHTING

Lighting Requirements in Streets

When designing or making changes in street lighting, it is important to first understand the light requirements of the road. Street lighting in India is classified in the Indian Standard (BIS, 1981), based on the traffic density of the road (see Table 1). Based on the classification in the code, the Lighting Designer matches the category of road, and designs and provides installation specifications for the street lighting system.

Retrofit or New Installation

Based on the purpose and lighting requirements of the roadway as well as the age of the existing lighting infrastructure, decisions have to be taken whether new design and installation of street lighting is required, or whether project goals can be accomplished by retrofitting the existing lighting system. To retrofit existing street lighting, it must be determined whether existing poles can be used with replacement of only the luminaires.

Retrofitting

Retrofitting is generally considered for energy and maintenance savings. Sometimes it is necessary to retrofit or replace luminaires or a pole – e.g., in cases where light is not distributed correctly, or where a pole has been damaged. Opportunities for significant efficiency improvements are limited in these cases, since the pole location does not change.

New Installation or Replacement

This option involves removing existing street lighting and installing new equipment, or designing and installing a completely new system where street lighting did not previously exist. This option provides greater flexibility in the design with regard to location and number of poles. If a main street improvement project is planned, new poles and lighting fixtures may be the best option for the most effective energy-efficient design of the street lighting system.

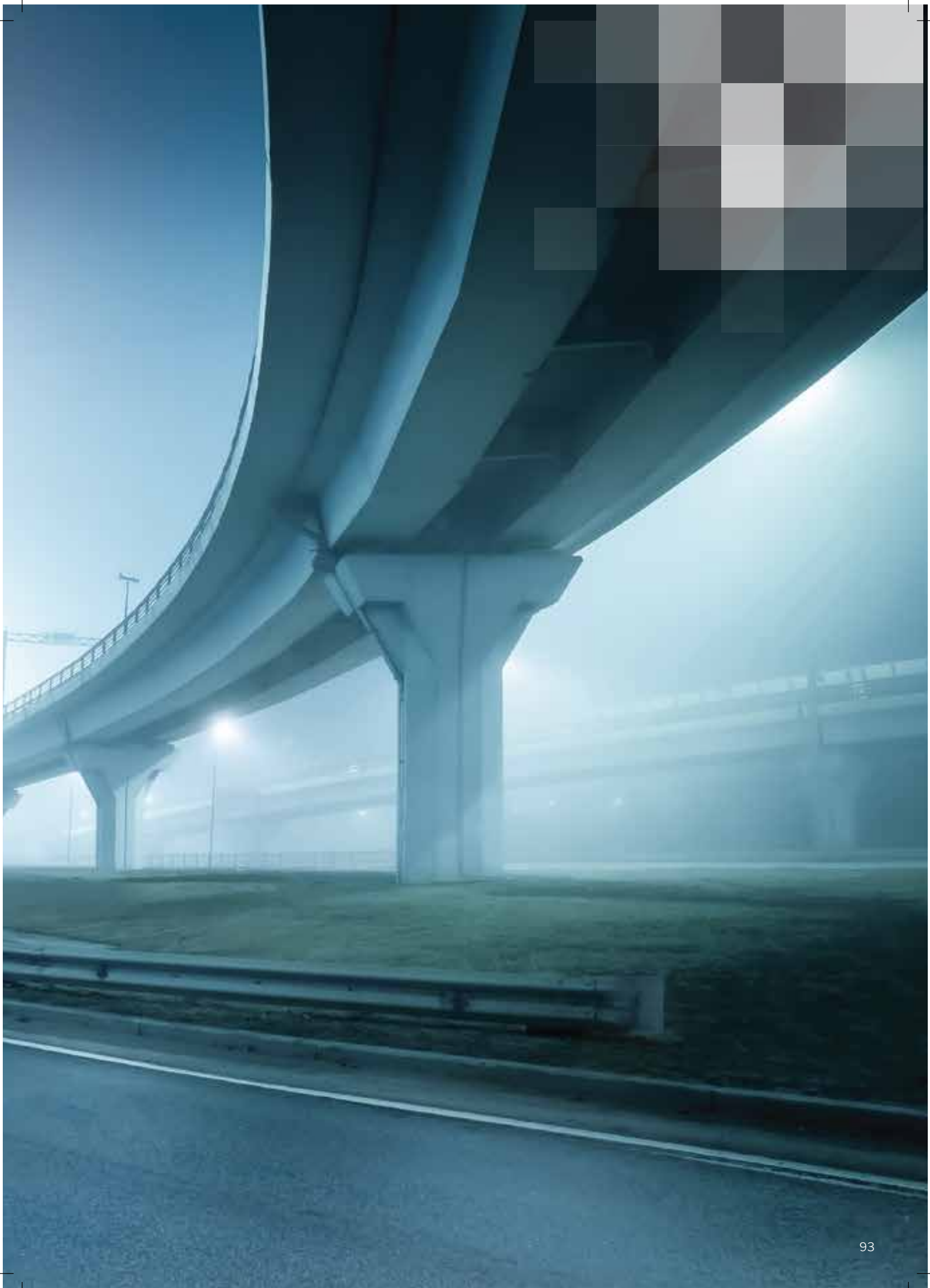

Table 1: Classification of Roads (BIS, 1981)

Group	Description
A1	For very important routes with rapid and dense traffic where the only considerations are the safety and speed of the traffic and the comfort of drivers
A2	For main roads with considerable mixed traffic like main city streets, arterial roads, and thoroughfares
B1	For secondary roads with considerable traffic such as local traffic routes, and shopping streets
B2	For secondary roads with light traffic
C	For residential and unclassified roads not included in the previous groups
D	For bridges and flyovers
F	For roads with special requirements such as roads near airports, and railways

Luminaires are Classified Into Three Categories according to the Degree of Glare (BIS, 1981)

Cutoff luminaire: A luminaire whose light distribution is characterized by rapid reduction of luminous intensity in the region between about 80° and the horizontal. The direction of maximum intensity may vary but should be below 65°. The principal advantage of the cutoff system is the reduction of glare.

Semi-cutoff luminaire: A luminaire whose light distribution is characterized by a less severe reduction in the intensity in the region of 80° to 90°. The direction of maximum intensity may vary but should be below 75°. The principal advantage of the semi-cutoff system is a greater flexibility in siting.

Non-cutoff luminaire: A luminaire where there is no limitation on light distribution at any angle. This luminaire is permissible when a certain amount of glare may be accepted (when daytime appearance of the street is important) and when the luminaires are large and have reduced brightness.

Table 2: Recommended Levels of Illumination (BIS, 1981)

Types of Road	Road Characteristics	Average Level of Illumination on Road Surface in Lux	Ratio of Minimum/Average Illumination	Type of Luminaire Preferred
A-1	Important traffic routes carrying fast traffic	30	0.4	Cutoff
A-2	Main roads carrying mixed traffic like city main roads/streets, arterial roads, throughways	15	0.4	Cutoff
B-1	Secondary roads with considerable traffic like local traffic routes, shopping streets	8	0.3	Cutoff or semi-cutoff
B-2	Secondary roads with considerable traffic like local traffic routes, shopping streets	4	0.3	Cutoff or semi-cutoff

Table 3: Specifications for Street Lighting Poles (BIS, 1981)

Section	Overall length 11 m + 25 mm (base plate)			Overall length 9.5 m +25 mm (base plate)		
	Outside Dia (mm)	Thickness (mm)	Length (mm)	Outside Dia (mm)	Thickness (mm)	Length (mm)
Bottom section	139.7	4.85	5600	165.1	4.85	5000
Middle section	114.3	4.5	2700	139.7	4.5	2250
Top section	88.9	3.25	2700	114.3	3.65	2250
Planting depth	1800 mm			1800 mm		
Nominal weight of the pole	160 kg			147 kg		
Tolerance on mean weight for bulk supply is 7.5 %						
Tolerance for single pole weight is 10%						

Table 4: Mounting Height of Luminaires (BIS, 1981)

Group	A	B	Others (Roads Bordered by Trees)
Recommended Mounting Height	9 to 10 meters	7.5 to 9 meters	Less than 7.5 meters

SPACING

Spacing is the distance, measured along the center line of the road, between successive luminaires in an installation. To preserve longitudinal uniformity, the space-height ratio should generally be greater than 3.

OUTREACH

Outreach is the horizontal distance between the center of the column and the center of the luminaire and is usually determined for architectural aesthetic considerations.

OVERHANG

Overhang is the horizontal distance between the center of a luminaire mounted on a bracket and the adjacent edge of a carriage way. In general, overhang should not exceed one-fourth of the mounting height to avoid reduced visibility of curbs, obstacles, and footpaths.



Figure 1: Street Lighting Features (BIS, 1981)

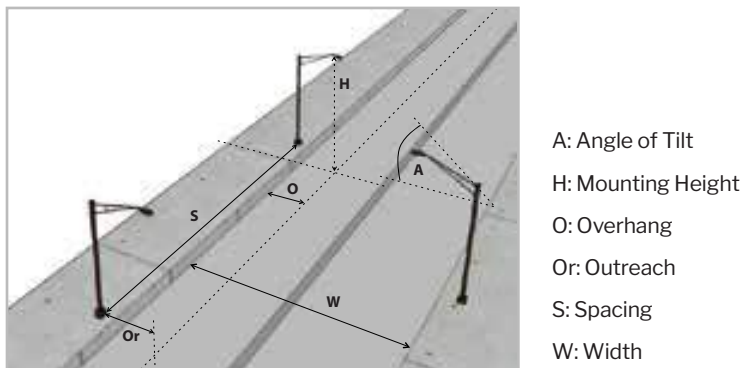

SITING OF LUMINAIRES

FOUR FUNDAMENTAL TYPES OF SITING ARRANGEMENTS ARE RECOGNIZED IN STREET LIGHTING (BIS, 1981).

- 1. Single side arrangement:** Where all the luminaires are on one side of the road. This is recommended only when the width of the road is equal to or less than the mounting height.
- 2. Staggered arrangement:** Where the luminaires are placed on either side of the road in a zigzag formation. This is recommended when the road width is 1 to 1.5 times that of the mounting height.
- 3. Opposite mounting:** Where the luminaires are situated on either side of the road opposite to one another. This is advisable for road widths more than 1.5 times that of the mounting height.
- 4. Axial mounting:** Where the luminaires are placed along the axis of the road. This is recommended for narrow roads the width of which does not exceed the mounting height.

LED STREET LIGHT

BLOOM PRO

15W/20W/25W/30W/35W

LED Streetlight with innovative, aesthetic and robust design with pressure die cast aluminium housing with UV stabilized PC IP diffuser for better light distribution.



High on Efficacy
Efficacy > 110lm/W



Robust Design
Innovative, aesthetic and robust design with pressure die cast aluminium housing and UV stabilized IP PC Lens for better light distribution



Wide Operating Voltage / Rated Voltage
140-270V AC / 220-240V AC/50Hz



Safe & Reliable
High Surge Protection: 6kV
Power Factor >0.95



High Performance Electronic Driver
15W / 20W/ 25W: Non Potted Driver
30W / 35W: Potted Driver



Higher Life
Life: 25,000 BH @ L70B50



Operating Temperature
-10°C to + 45°C

APPLICATIONS

Parking Area

Road Lighting

Residential Colonies

Internal Road

Industrial Periphery



TECHNICAL SPECIFICATION

Product Code	System Wattage (W)	LxWxH (mm)	THD	Colour Temp. (CCT)	Weight (kg)
PSTM27158	15W	320x97x55	≤ 10%	5700K	0.85
PSTM27208	20W	320x97x55	≤ 10%	5700K	0.85
PSTM27258	25W	320x97x55	≤ 10%	5700K	0.85
PSTM27308	30W	320x97x55	≤ 10%	5700K	0.85
PSTM27358	35W	320x97x55	≤ 10%	5700K	0.85

Pole Dia - Suitable upto 40mm OD

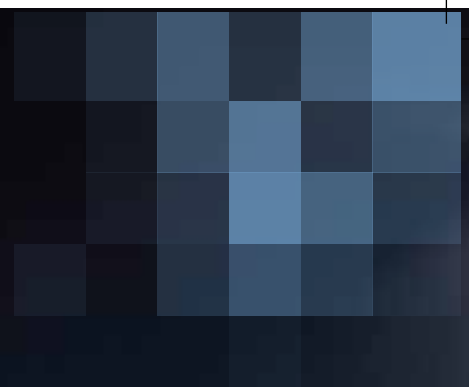

LED STREET LIGHT

BLOOM PRO

45W/60W

LED Streetlight with innovative, aesthetic and robust design with pressure die cast aluminium housing with UV stabilized PC IP lens for better light distribution.



High on Efficacy
Efficacy > 110lm/W



Robust Design
Innovative, aesthetic and robust design with pressure die cast aluminium housing and UV stabilized IP PC Lens for better light distribution



Wide Operating Voltage / Rated Voltage
140-270V AC / 220-240V AC/50Hz



Safe & Reliable
High Surge Protection: 6kV for 45W,
4kV + 10kV SPD inbuilt for 60W
Power Factor >0.95



High Performance Electronic Driver
Potted Driver



Higher Life
Life: 50,000 BH @ L70B50



Operating Temperature
-10°C to + 45°C

APPLICATIONS

Parking Area

Road Lighting

Residential Colonies

Internal Road

Industrial Periphery



TECHNICAL SPECIFICATION

Product Code	System Wattage (W)	LxWxH (mm)	THD	Colour Temp. (CCT)	Weight (kg)
PSTM27458	45W	348x92x72	≤ 10%	5700K	1.20
PSTM27608	60W	348x92x72	≤ 10%	5700K	1.20

Pole Dia - Suitable upto 45mm OD

LED STREET LIGHT

BLOOM PRO

90W

LED Streetlight with innovative, aesthetic and robust design with pressure die cast aluminium housing with frame and IP PC lens for better light distribution.

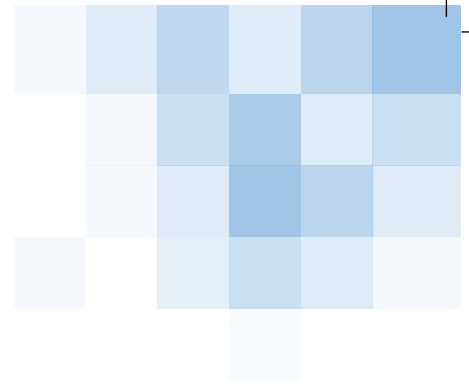

High on Efficacy
Efficacy > 100lm/W



Robust Design
Innovative, aesthetic and robust design with pressure die cast aluminium housing and UV stabilized IP PC Lens for better light distribution



Wide Operating Voltage / Rated Voltage
140-270V AC / 220-240V AC/50Hz



Safe & Reliable
High Surge Protection:
4kV+10kV SPD inbuilt
Power Factor >0.95



High Performance Electronic Driver
15W / 20W/ 25W: Non Potted Driver
30W / 35W: Potted Driver



Higher Life
Life: 50,000 BH @ L70B50



Operating Temperature
-10°C to + 45°C

APPLICATIONS

Parking Area

Road Lighting

IT Parks

Residential Colonies

Internal Road

Industrial Periphery



TECHNICAL SPECIFICATION

Product Code	System Wattage (W)	LxWxH (mm)	THD	Colour Temp. (CCT)	Weight (kg)
PSTM22908R1	90W	344x212x97	≤ 10%	5700K	2.5

Pole Dia - Suitable upto 60mm OD

LED STREET LIGHT

BLOOM PRO

120W/135W/150W

LED Streetlight with innovative, aesthetic and robust design with pressure die cast aluminium housing with frame, toughened glass and PC lens for better light distribution.



High on Efficacy
Efficacy > 110lm/W



Robust Design
Innovative, aesthetic and robust design with pressure die cast aluminium housing with frame, toughened glass and PC lens for better light distribution



Wide Operating Voltage / Rated Voltage
140-270V AC / 220-240V AC/50Hz



Safe & Reliable
High Surge Protection: 4kV+10kV
Power Factor: >0.95

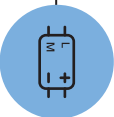

High Performance Electronic Driver
Potted driver for better thermal reliability, easy maintenance



Higher Life
Life: 50,000 BH @ L70B50



Operating Temperature
-10°C to + 45°C

APPLICATIONS

Parking Area

Road Lighting

IT Parks

National Highway



TECHNICAL SPECIFICATION

Product Code	System Wattage (W)	LxWxH (mm)	THD	Colour Temp. (CCT)	Weight (kg)
PSTM22CD8	120W	445x280x80	≤ 10%	5700K	4.4
PSTM231358	135W	445x280x80	≤ 10%	5700K	4.4
PSTM22FG8	150W	445x280x80	≤ 10%	5700K	4.4

Pole Dia - Suitable upto 60mm OD



LED STREET LIGHT

BLOOM PRO

180W/200W

LED Streetlight with innovative, aesthetic and robust design with pressure die cast aluminium housing with frame, toughened glass and PC lens for better light distribution.



High on Efficacy
Efficacy > 110lm/W



Robust Design
Innovative, aesthetic and robust design with pressure die cast aluminium housing with frame, toughened glass and PC lens for better light distribution



Wide Operating Voltage / Rated Voltage
140-270V AC / 220-240V AC/50Hz



Safe & Reliable
High Surge Protection: 4kV+10kV SPD inbuilt
Power Factor >0.95



High Performance Electronic Driver
Potted driver for better thermal reliability, easy maintenance



Higher Life
Life: 50,000 BH @ L70B50



Operating Temperature
-10°C to + 45°C

APPLICATIONS

Parking Area

Road Lighting

IT Parks

National Highway



TECHNICAL SPECIFICATION

Product Code	System Wattage (W)	LxWxH (mm)	THD	Colour Temp. (CCT)	Weight (kg)
PSTM23KL8	180W	535x265x95	≤ 10%	5700K	5.7
PSTM23MN8	200W	535x265x95	≤ 10%	5700K	5.7

Pole Dia - Suitable upto 60mm OD

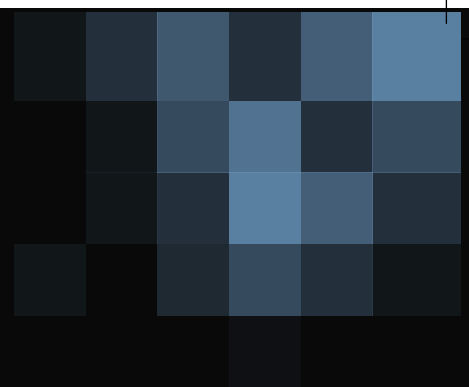

LED STREET LIGHT

BLOOM PRO

220W/250W

LED Streetlight with innovative, aesthetic and robust design with pressure die cast aluminium housing with frame, toughened glass and PC lens for better light distribution.



High on Efficacy
Efficacy > 110lm/W



Robust Design
Innovative, aesthetic and robust design with pressure die cast aluminium housing with frame, toughened glass and PC lens for better light distribution



Wide Operating Voltage / Rated Voltage
140-270V AC / 220-240V AC/50Hz



Safe & Reliable
High Surge Protection: 4kV+10kV
Power Factor: >0.95



High Performance Electronic Driver
Potted driver for better thermal reliability, easy maintenance



Higher Life
Life: 50,000 BH @ L70B50



Operating Temperature
-10°C to + 45°C

APPLICATIONS

Parking Area

Road Lighting

IT Parks

National Highway



TECHNICAL SPECIFICATION

Product Code	System Wattage (W)	LxWxH (mm)	THD	Colour Temp. (CCT)	Weight (kg)
PSTM230P8	220W	657x345x110	≤ 10%	5700K	9.8
PSTM23RS8	250W	657x345x110	≤ 10%	5700K	9.8

Pole Dia - Suitable upto 60mm OD

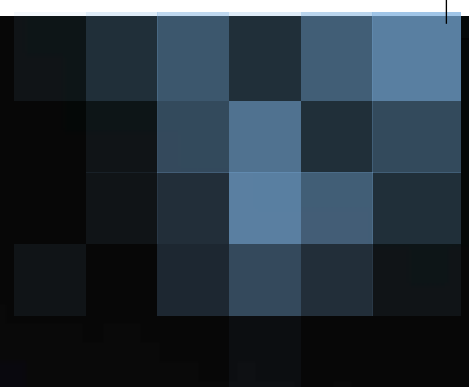

LED STREET LIGHT

BLOOM

120W/150W/180W

Bloom street light luminaire comprises of die cast aluminium housing with frame, toughened glass and PC lens, pipe mounting. This luminaire is recommended for illuminating access roads, traffic routes etc.



High on Efficacy

Efficacy > 110/120lm/W



Robust Design

Innovative, aesthetic and robust design with pressure die cast aluminium housing with frame, toughened glass and PC lens for better light distribution



Wide Operating Voltage / Rated Voltage

220 -240V AC / 220-240V AC/50Hz



Safe & Reliable

High Surge Protection: 4kV + 10kV SPD inbuilt for 60W
Power Factor >0.95



High Performance Electronic Driver

Constant Current Integral Driver, Potted driver for better thermal reliability, easy maintenance



Higher Life

Life: 50,000 BH @ L70B50



Operating Temperature

-10°C to + 45°C

APPLICATIONS

Parking Area

Road Lighting

Residential Colonies

Internal Road

Industrial Periphery



TECHNICAL SPECIFICATION

Product Code	System Wattage (W)	LxWxH (mm)	THD	Colour Temp. (CCT)	Weight (kg)
PSTM16CD8#	120W	486x237x116	≤ 10%	5700K	3.6
PSTM16CD8A*	120W	486x237x116	≤ 10%	5700K	4.8
PSTM16FG8#	150W	556x262x116	≤ 10%	5700K	4.8
PSTM16FG8A*	150W	556x262x116	≤ 10%	5700K	4.8
PSTM16KL8#	180W	556x262x116	≤ 10%	5700K	6.6

Pole Dia - PSTM16CD8 & PSTM16FG8 suitable upto 55mm OD

PSTM16KL8, PSTM16CD8A* & PSTM16FG8A* - suitable upto 60mm OD

*A-Series with 1-10V analog dimming.

Product with 110 lm/W

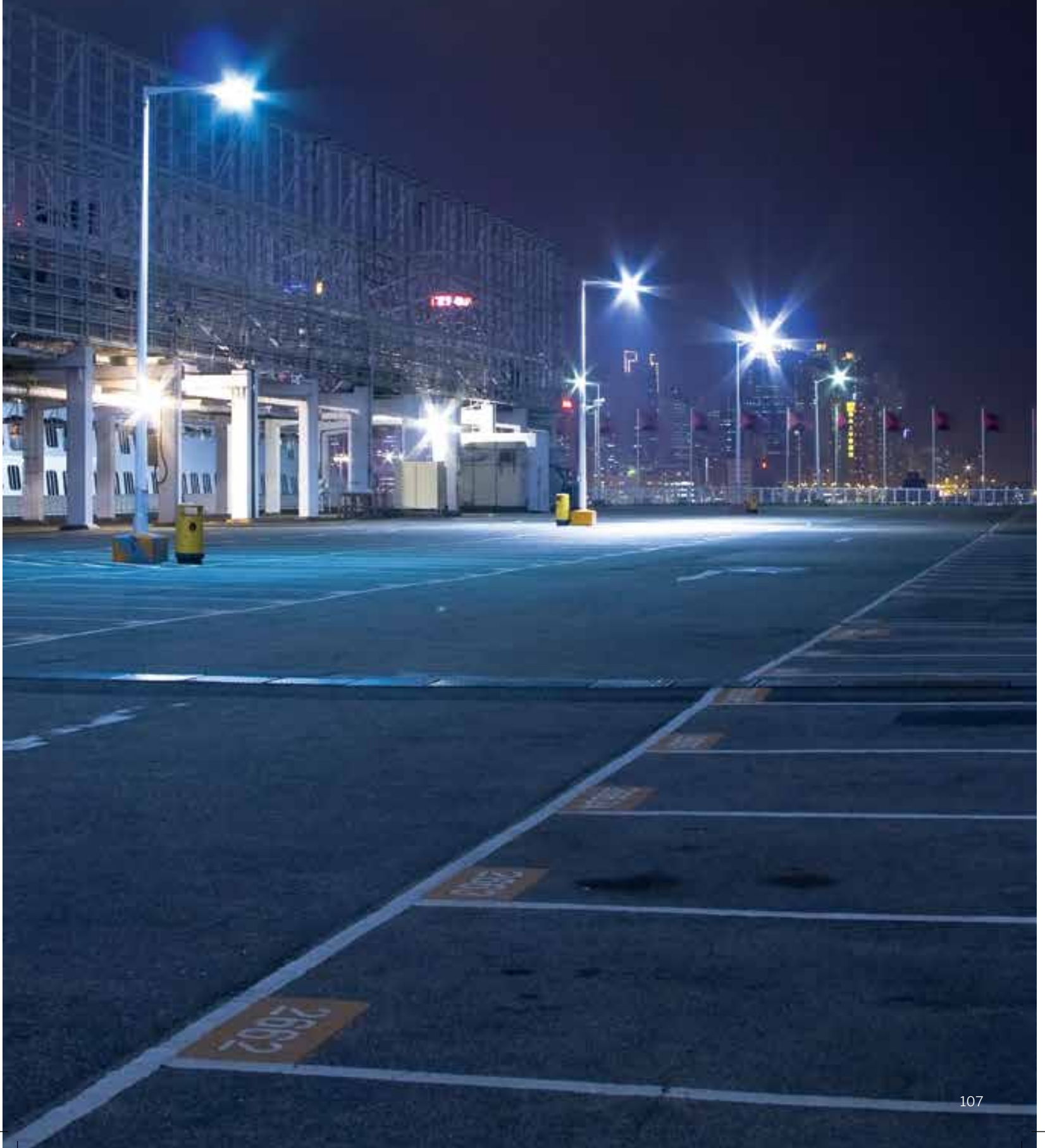
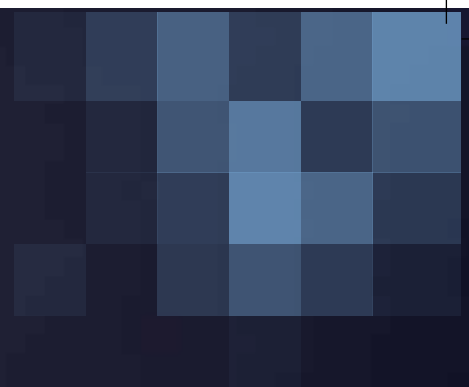

LED STREET LIGHT

BLOOM

200W/220W/250W

Bloom street light luminaire comprises of die cast aluminium housing with frame, toughened glass and PC lens, pipe mounting. This luminaire is recommended for illuminating access roads, traffic routes etc.



High on Efficacy

Efficacy > 110/135lm/W



Robust Design

Innovative, aesthetic and robust design with pressure die cast aluminium housing with frame, toughened glass and PC lens for better light distribution



Wide Operating Voltage / Rated Voltage

220 -240V AC / 220-240V AC/50Hz



Safe & Reliable

High Surge Protection: 4kV + 10kV SPD inbuilt
Power Factor >0.95



High Performance Electronic Driver

Constant Current Integral Driver, Potted driver for better thermal reliability, easy maintenance



Higher Life

Life: 50,000 BH @ L70B50



Operating Temperature

-10°C to + 45°C

APPLICATIONS

IT Park

Road Lighting

National Highway

Industrial Periphery



TECHNICAL SPECIFICATION

Product Code	System Wattage (W)	LxWxH (mm)	THD	Colour Temp. (CCT)	Weight (kg)
PSTM16MN8	200W	577x292x130	≤ 10%	5700K	6.6
PSTM16OP8	220W	577x292x130	≤ 10%	5700K	6.6
PSTM16RS8N [#]	250W	625x320x125	≤ 10%	5700K	7.0
PSTM16RS8	250W	625x320x125	≤ 10%	5700K	8.0

Pole Dia - Suitable upto 60mm OD

[#] Product with 135 lm/W

LED STREET LIGHT

BLOOM

60W/75W/90W/100W

Bloom street light luminaire comprises of die cast aluminium housing with frame, toughened glass and PC lens, pipe mounting. This luminaire is recommended for illuminating access roads, traffic routes etc.



High on Efficacy
Efficacy > 110lm/W



Robust Design
Innovative, aesthetic and robust design with pressure die cast aluminium housing with frame, toughened glass and PC lens for better light distribution



Wide Operating Voltage / Rated Voltage
240V AC / 220-240V AC/50Hz



Safe & Reliable
High Surge Protection: 4kV + 10kV SPD inbuilt
Power Factor >0.95



High Performance Electronic Driver
Constant Current Integral Driver, Potted driver for better thermal reliability, easy maintenance



Higher Life
Life: 50,000 BH @ L70B50



Operating Temperature
-10°C to + 45°C

APPLICATIONS

Parking Area

Road Lighting

Residential Colonies

Internal Road

Industrial



TECHNICAL SPECIFICATION

Product Code	System Wattage (W)	LxWxH (mm)	THD	Colour Temp. (CCT)	Weight (kg)
PSTM22608	60W	362x232x72	≤ 10%	5700K	3.0
PSTM22758	75W	362x232x72	≤ 10%	5700K	3.0
PSTM22908	90W	362x232x87	≤ 10%	5700K	3.0
PSTM22AB8	100W	344x212x97	≤ 10%	5700K	3.0

Pole Dia - PSTM22608, PSTM22758 suitable upto 45mm OD
PSTM22908, PSTM22AB8 suitable upto 60mm OD

conexion

Smart Street Lighting System

Traditionally, street lights exist in either “On” or “Off” state leading to wastage of energy, increased costs when over illuminated and cause safety and security hazards when under illuminated.

The intricate requirements of the transportation network demands varied levels of illumination based on ever changing situations. Smart Street light contribute to more livable cities by helping to improve safety and reduce congestion, reduce energy cost.

The need of the hour is Smart lighting, Lighting that is efficient, can be controlled from a remote location and can be programmed according to one’s convenience.

Introducing CONEXION, an intelligent solution to manage all your street lighting needs.

CONEXION street lights can be remotely monitored and controlled by any device having an internet access, program your street lights for changing situations, monitor individual parameters, control dimming, manage assets, generate actionable reports, analyze, optimize and much more.

Usher in the future with CONEXION system today! With Panasonic leading the way, the future is smart and bright.

BENEFITS



Seamless Dimming



Alarms and Events



GIS Mapping



Security



Remote Monitoring and Control



High System Efficacy



Sensor Interface



Communication Agnostic

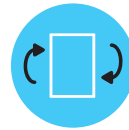

Tilt Management



Temperature Management



Individual Control

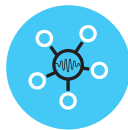

Experience in RF Topology Mapping



Zigbee / Lora & M2M Compatibility

There are two common ways of automatic smart streetlight :-

1) Group Control Lighting management system

- Controller located in feeder panel and control streetlights distributed on 3 phase under that feeder.
- It can only turn streetlights ON or OFF. This controller communicate with central server using GPRS, received command and execute.

2) Individual addressable streetlight management system

- Central controller can be placed in feeder panel
- Central controller talk to individual streetlight through wireless
- Communication to streetlight can be either turn them ON/OFF or DIM
- These controller also report faults with luminaire.

SYSTEM ARCHITECTURE

Cutoff luminaire: A luminaire whose light distribution is characterized by rapid reduction of luminous intensity in the region between about 80° and the horizontal. The direction of maximum intensity may vary but should be below 65°. The principal advantage of the cutoff system is the reduction of glare.

Semi-cutoff luminaire: A luminaire whose light distribution is characterized by a less severe reduction in the intensity in the region of 80° to 90°. The direction of maximum intensity may vary but should be below 75°. The principal advantage of the semi-cutoff system is a greater flexibility in siting.

Non-cutoff luminaire: A luminaire where there is no limitation on light distribution at any angle. This luminaire is permissible when a certain amount of glare may be accepted (when daytime appearance of the street is important) and when the luminaires are large and have reduced brightness.



LED SMART STREET LIGHT

Excellent energy efficient performance
 IK10, IP66, separate optical & control compartments
 Potted driver, IP67
 Lamp controller IP67 with lighting protection

DASHBOARD, REPORTS & ANALYTICS

Powerful dash boarding
 Generate actionable reports
 Export logs and reports
 Predict your maintenance activity

USER & ASSET MANAGEMENT

Manage user permissions
 Generate multiple projects
 Tag assets and monitor individual parameters
 Sort by street, category and groups

WEB APPLICATION

Secure and safe
 Intuitive user interface
 Scalable, flexible & responsive
 Access via PC, tablet or phone

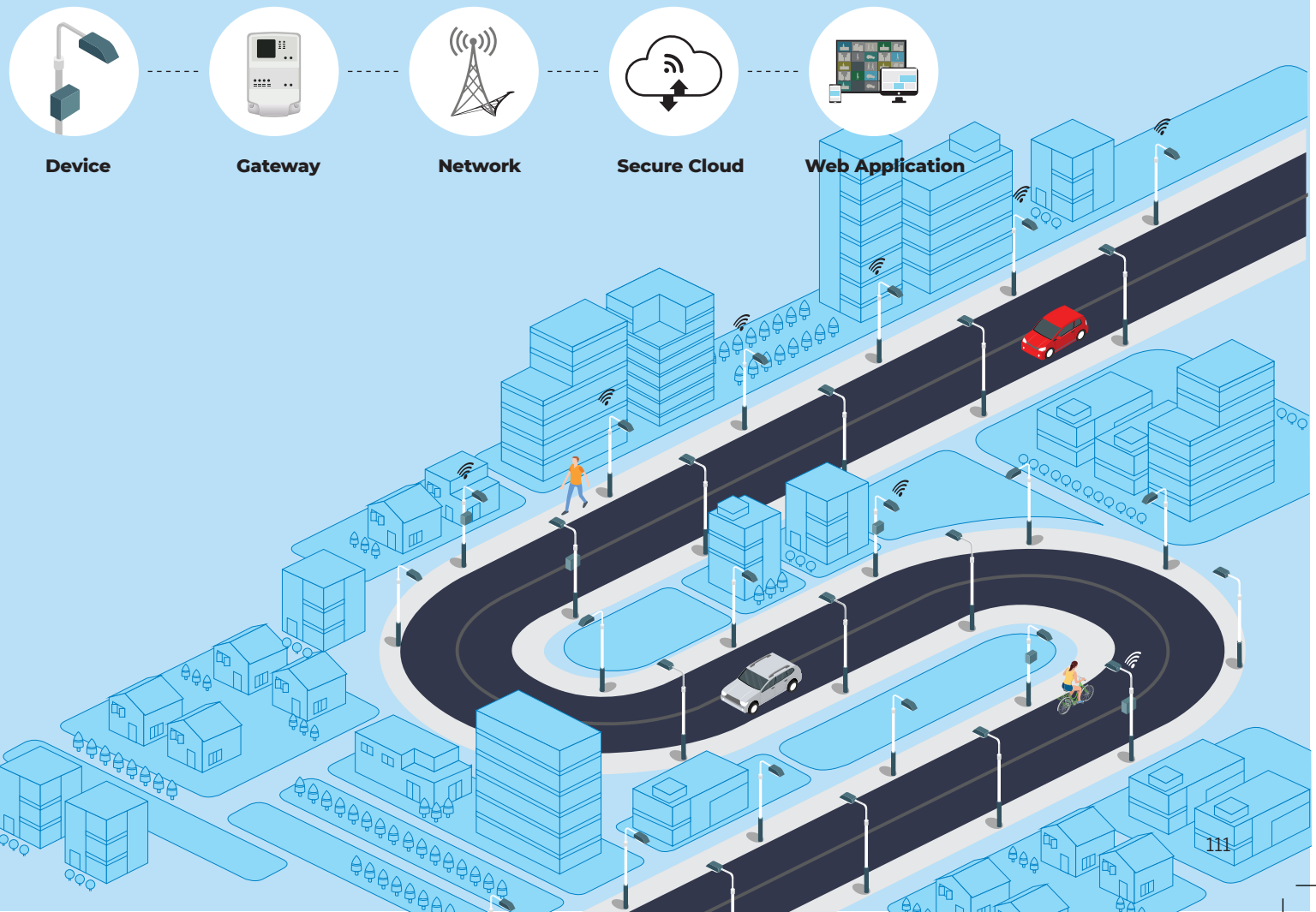

SMART STREET LIGHTING

Hybrid System Panasonic is combination from 3 systems (GSM, RF and PLC)

Control & monitoring your asset with our asset management application

Manage energy consumption with dimming function

Asset security can control better cause using local server & local provider

Measuring energy consumption of each lamp or group

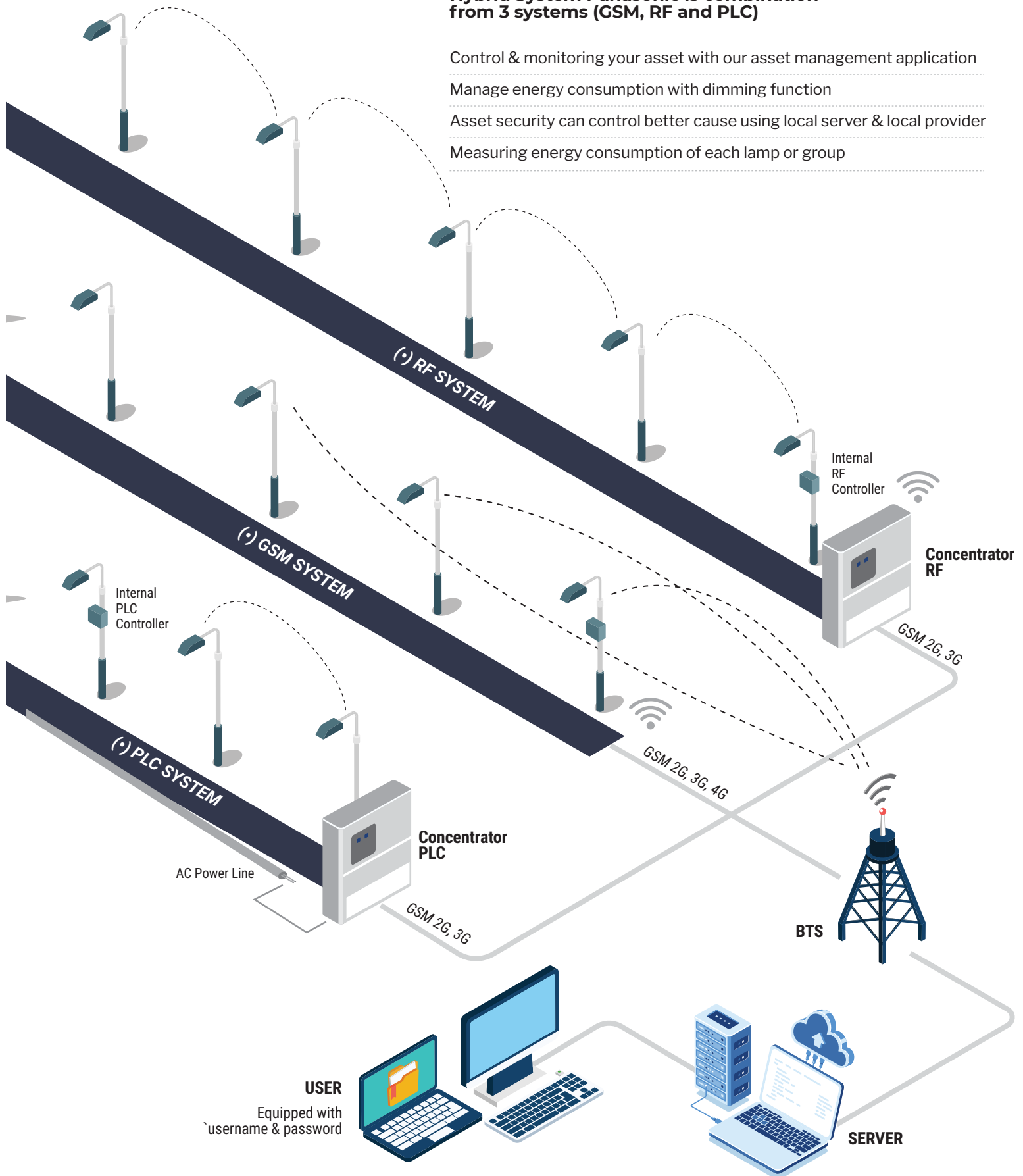

TYPICAL USING SMART STREET LIGHT

With Panasonic Smart System, we can use street light more flexible, with GSM, RF-GSM and PLC-GSM.

GSM

Separately, with minimalist totally of the lamp, such as 1-10 lamp.

Lamp must be in good signal condition.

No need panel controller.

RF - GSM

More efficient in grouping area, 1 Concentrator can control until 200 luminaire.

Can working in areas where the GSM signal is unequal.

Such as subway, underpass, tunnel, etc.

Equipped with measurement and control features in the Concentrator panel.

PLC - GSM

More efficient in grouping area with a wiring standard. 1 Concentrator can control more than 200 luminaire. And suitable in street such as street at the mountain.

PLC with internal controller suitable to use in the pole with constant distance.

PLC with external controller suitable to use in the pole with not constant distance.

Can working in areas where the GSM signal is unequal, because using cable for the communication

Communication of the lamp using cable PJU and not easily distracted from external signal

From the advantages and disadvantages of each TECHNOLOGY of the LIGHTS, HYBRID TECHNOLOGY more suitable to complete each other, so that is a RELIABLE system.

Conclusion :

Hybrid Technology is integrated of system GSM, system RF-GSM and system PLC-GSM so that it can be easily applied to all areas can be easily to control of the lamp from web using internet.

FEATURES

	GSM	RF (Zigbee - GSM)	PLC - GSM
Distance	~ 20 to 30km (Lamp to BTS)	~ 1 50m (Lamp `Lamp) (Lamp to DCU)	~ 100m (Lamp to Lamp) (Lamp to DCU)
Structure	Client - Server	Mesh, Star, Ad HOC, P2P	Power line communication
Frequency	900Mhz - 1800Mhz	RF: 2.4Ghz / ISM band (Country specific) GSM: 900Mhz - 1800Mhz	PLC: Primary - 125 - 140kHz PLC: Secondary - 95 - 125 kHz GSM: 900Mhz - 1800Mhz
Speed	86.5Kbps - 10Mbps	256Kbps	5.5Kbps
Nos of Lamps	10k to 15k lamps/BTS	150-200 lamps in group/DCU	150-200 lamps in group/DCU
Remarks	1. Can be used where public GSM is present 2. Communication depends upon weather conditions and network congestion 3. High Network Subscription cost	1. Unlicensed band 2. Additional DCU required 3. Low network subscription cost	1. Communication depends upon the existing wiring network 2. Additional DCU required 3. Low network subscription cost



SMART SYSTEM STREET LIGHT

Introducing “CONEXION”, an Intelligent solution to manage all your street lighting needs.

Conexion - street lights can be remotely monitored and controlled by any device having internet access.

Data shared by Intelligent Street Lighting solutions don't just show what's happening today, they can also predict what might happen tomorrow, helping cities plan more effectively for the future.



SPECIFICATIONS

Input Power	60W	90W	120W	200W
Color Temperature	5700K			
VAC Input	220-240 VAC			
Frequency	50 Hz			
Power Factor	> 0.95			
THD	≤ 10%			
IP Module	IP66			
IP Driver	IP66			
IP Lamp	IP66			
Cover Lens	IK-07			
Body	Die Casting Aluminum			
Life Time	50000 H			
Max Surge	4KV + 10KV SPD inbuilt			
Dimmable	0 - 100%			
Dimension LxWxH (mm)	362x232x72	362x232x87	445x280x80	535x265x95
Diameter Hole Pole	Φ 71mm			
Weight	3 Kg	3 Kg	4.4 Kg	5.7 Kg
Remark	1. Control each lamp or group 2. Certificate and testing report 3. Complete and available spare parts			

Pole Dia: 60W - Suitable upto 45mm OD; 90W, 120W , 200W - Suitable upto - 60mm OD

* Images and photographs shown herein are indicative only. We reserve the right to make changes in the data/details without prior notice.

CLOUD APPLICATION OVERVIEW



User Login



Project & User Control



Street Lighting Configuration



Direct Monitoring Lamp Condition



Reporting & Evaluation

SYSTEM INTERFACE

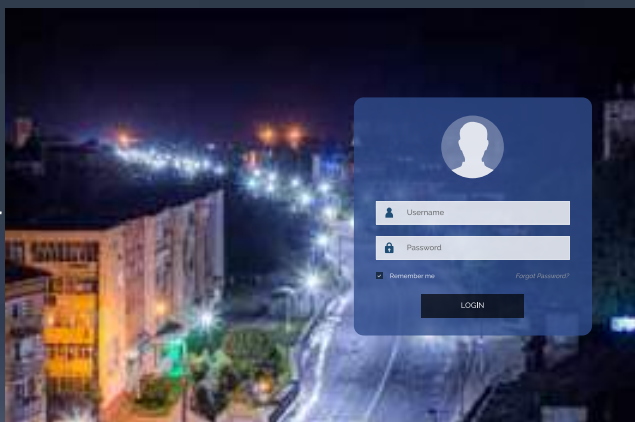

User Login

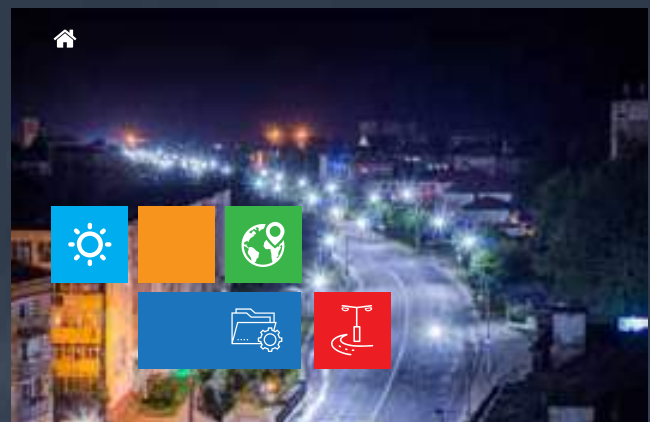

System Home



FLOOD LIGHTING

ULTIMATE RADIANCE
FOR WIDESPREAD AREAS

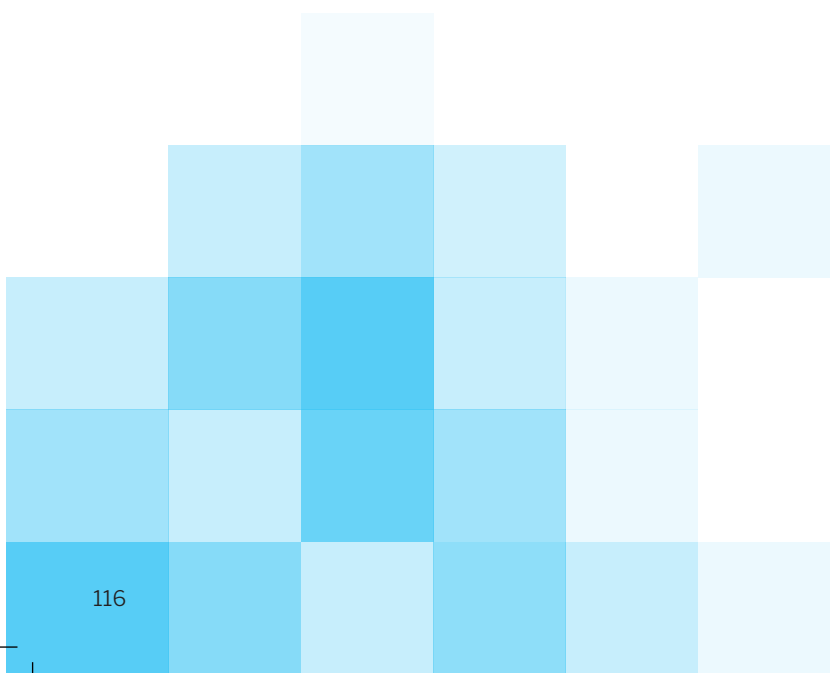

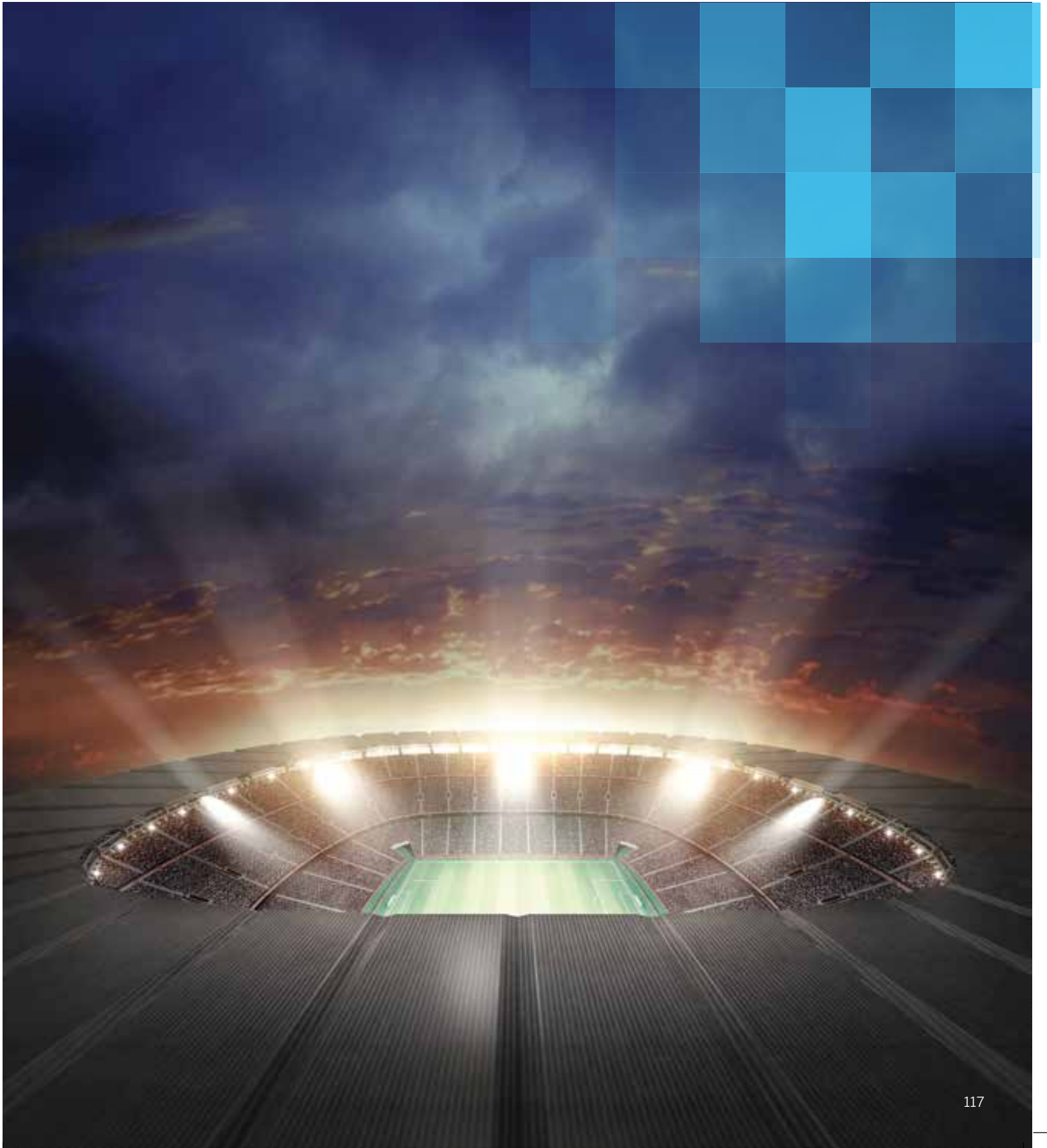

FLOOD LIGHTING

Flood lights are used to illuminate a wide area while projecting a broad angle. Be it hoardings, stadiums, tall buildings, with flood light luminaire, you can cover a wider range of surface when mounted at a well-defined and proper position.

Purpose of Flood Light:

Area lighting

Looking to light up larger areas such as recreational spots, yards, parking lots etc.? Flood lights are what you need. While the potential spill light and problems like glare control do not make it ideal for a pedestrian or urban-scale lighting, in high mast lighting systems, this is the best solution for you. They are usually installed in places away from residential complexes, healthcare institutions, and hotels.

Aim flood lights from the headframe of the high mast such that the area that needs most illumination is best lit. Make sure the high mast systems are such placed that they are at a distance from the target area; this way the interference with the area is minimal. Light distribution patterns and lumen packages can be such designed to work best with the high mast system.

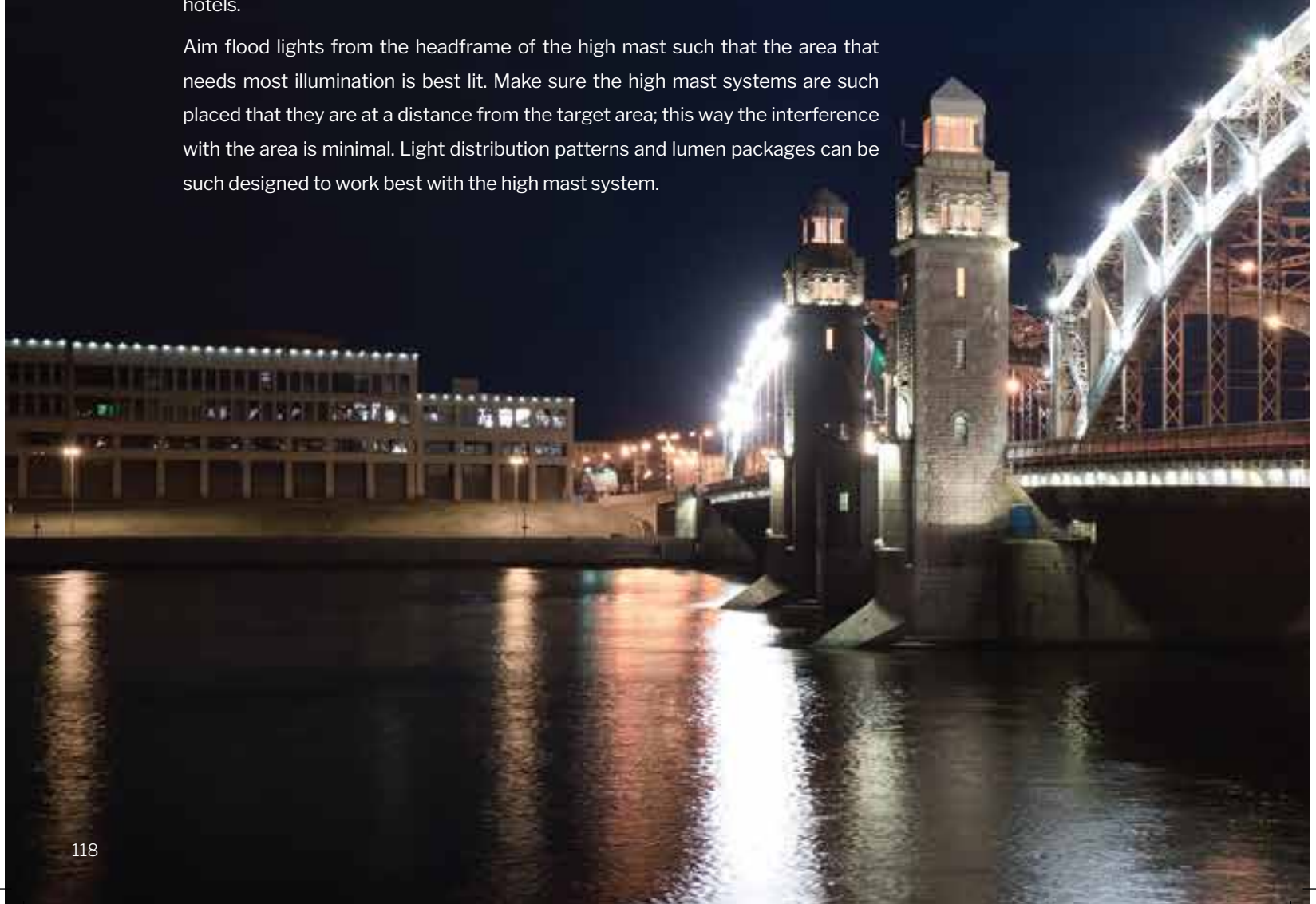

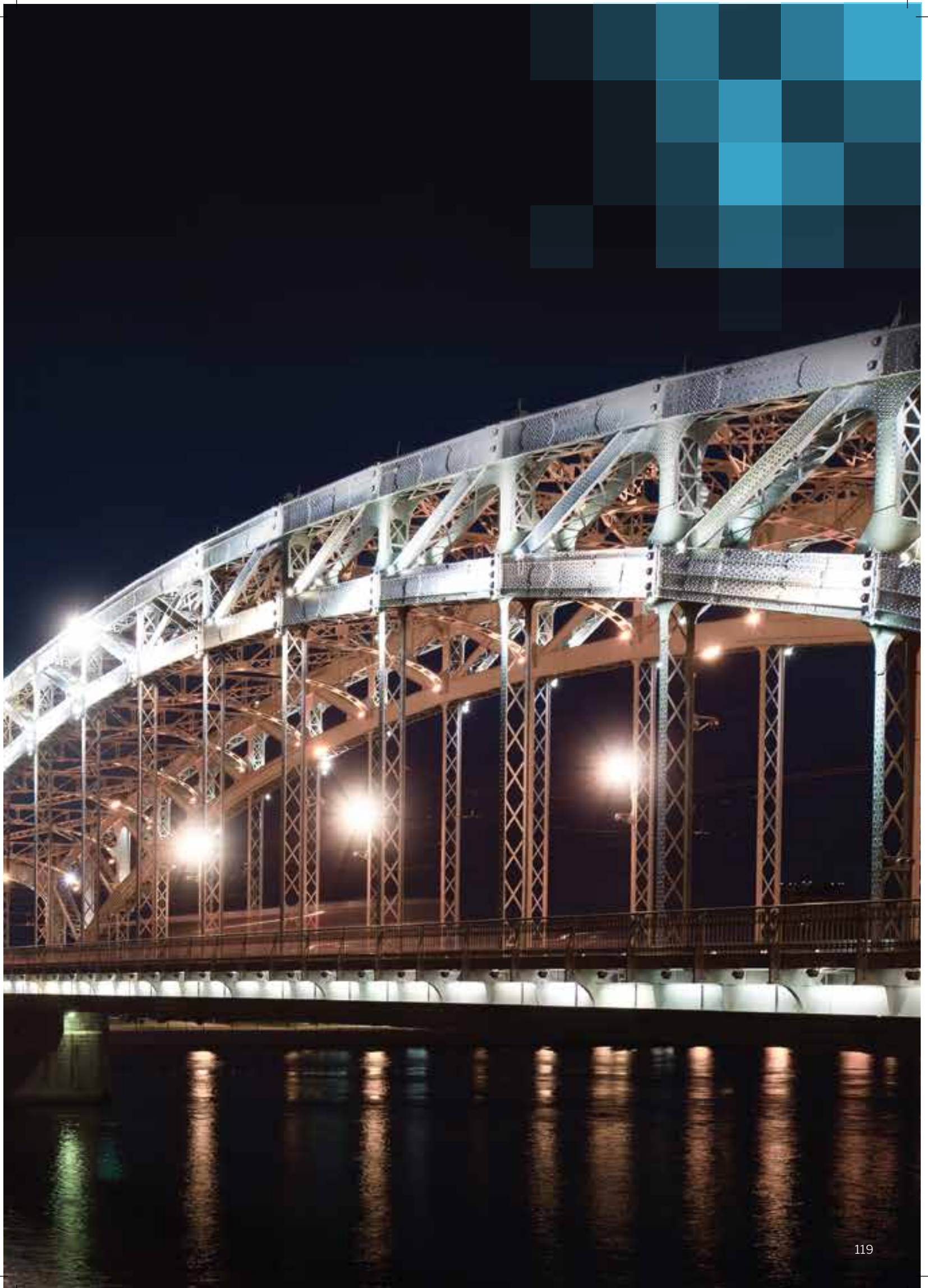

SPORTS LIGHTING



Among the key areas that find the best application of flood lights is sports. Stadiums, arenas and other outdoor facilities used for a variety of sports like cricket, football, tennis, motorsports etc. can be lit uniformly with flood lights. Herein, direct distribution flood lights are used for there usually are no structures for overhead light fixtures to be mounted on or surface for the bounced light from the playing area to be directed.

Several factors must be kept in mind while designing sports lighting. Some of these include mounting heights, light distribution, proper illuminance values, orientations among others.

Lighting here is provided from several directions to ensure proper visibility and modeling of the athletes; all these with obtrusive light and shadows being minimal.

AESTHETIC LIGHTING



To create drama, add beauty, dimension, depth, texture, space, and focal points in a landscape area, you need floodlighting. With flood lights key architectural elements of structures can be highlighted.

Through wash lighting, moonlighting, uplighting, silhouetting, spotting, and shadowing, softscape lighting for natural objects like trees and plants landscaping a building or area can be achieved.

A wide range of options remain open when it comes to lighting techniques for the most aesthetic result.



FACADE & STRUCTURE LIGHTING

When accentuating the significant architectural features of a structure, architectural floodlighting luminaires offer wall washing that illuminates complete walls uniformly, wall grazing to highlight certain elements of a vertical surface, and accent lighting that adds visual drama.

Enhance the charm, create fantastic impressions for structures with flood lights.

SECURITY LIGHTING (BORDER LIGHTING)

Flood lights are also useful when it comes to security lighting when installed at the perimeters of buildings and facilities used for residential, industrial or commercial purposes.

Such lighting often keeps anti-social activities in check offering a secure environment. Perimeter illumination provided by wide beam flood lights deter unwanted elements and activities, improve visibility and observation, and best support the use of other security devices.



INDUSTRIAL OUTDOOR LIGHTING

Floodlighting is also immensely helpful when lighting industrial parks and outdoor manufacturing facilities. Think refineries, rigs, chemical plants etc.

Area and task lighting become critical in such spaces because of the general atmosphere of high levels of humidity, vapours that are flammable, presence of materials often hazardous.

BILLBOARD LIGHTING

When providing light across billboards covering every edge and corner, flood lights are your best bet. It is particularly useful so the message on the billboards make a better impression on its audience in the night.



LED FLOOD LIGHT

FLANO

30W/50W

Flood light luminaire comprises of die cast Aluminium housing with frame, toughened glass and PC lens, cradle mounting.



High on Efficacy

Efficacy > 100lm/W



Robust Design

Innovative, aesthetic and robust design with toughened glass and PC lens for better light distribution.



Wide Operating Voltage / Rated Voltage

140-270V AC /
220-240V AC/50Hz



Safe & Reliable

High Surge Protection: 4kV+10kV
Power Factor >0.95



High Performance Electronic Driver

Potted driver for better thermal reliability, easy maintenance



Higher Life

Life: 50,000 BH @ L70B50



Operating Temperature

-10°C to +45°C

APPLICATIONS

Signboards
Buildings & Monuments
Billboards
Shopboards
Factories & Assembly Lines
Security & Perimeter Lighting



TECHNICAL SPECIFICATION

Product Code	System Wattage (W)	Dimension LXWXH	THD	Colour Temp. (CCT)	Weight (kg)
PFLM11308	30W	217X177X41	≤ 10%	5700K	1.2
PFLM11508	50W	242X231X53	≤ 10%	5700K	3.0

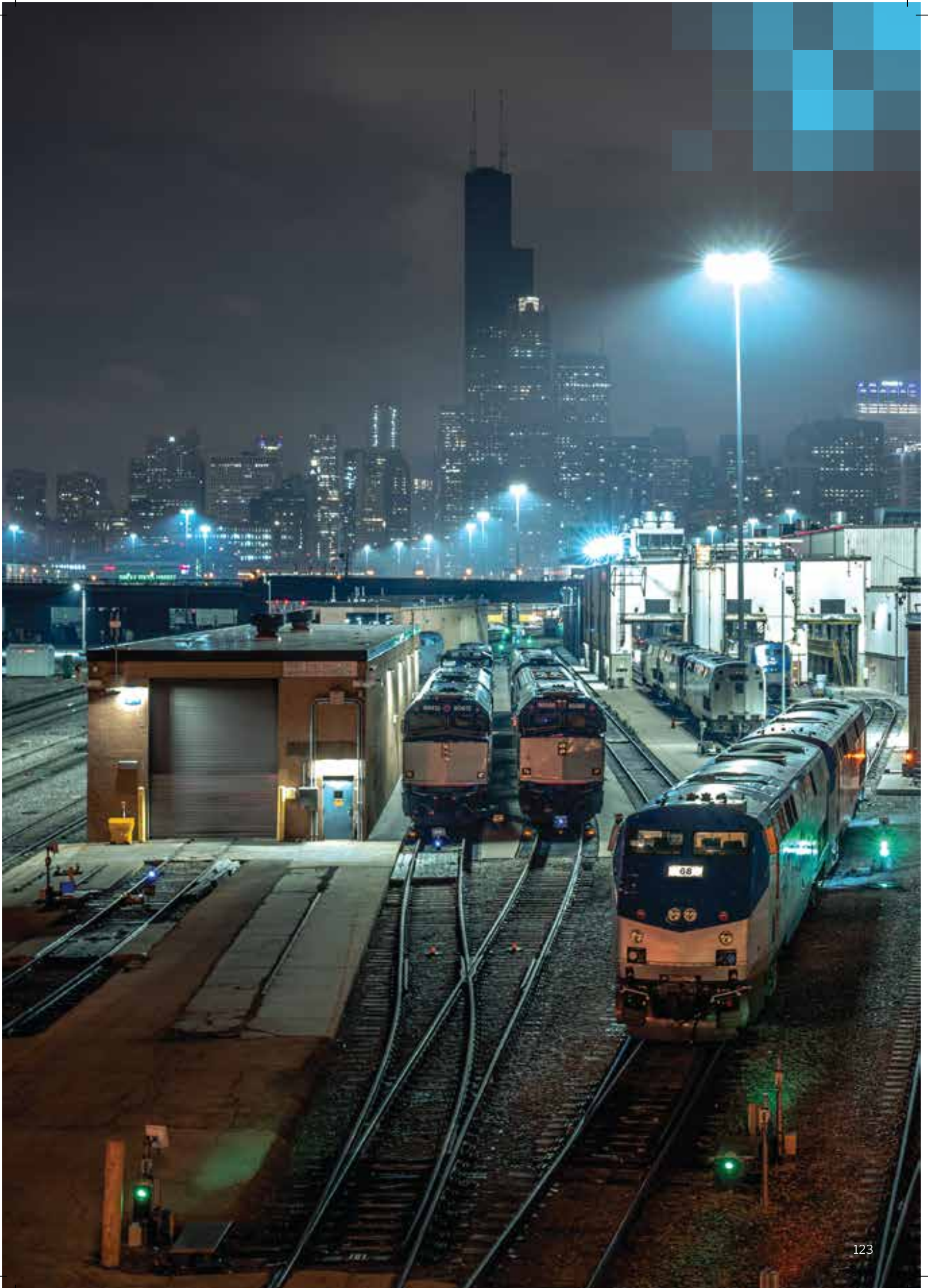

LED FLOOD LIGHT

FLANO PRO

50W/70W

Flood light luminaire comprises of die cast aluminium housing with toughened glass and PC lens, cradle mounting.



High on Efficacy

Efficacy > 100lm/W



Robust Design

Innovative, aesthetic and robust design with toughened glass and PC lens for better light distribution.



Wide Operating Voltage / Rated Voltage

140-270V AC /
220-240V AC/50Hz



Safe & Reliable

High Surge Protection: 4kV+10kV
Power Factor >0.95



High Performance Electronic Driver

Potted driver for better thermal reliability, easy maintenance



Higher Life

Life: 50,000 BH @ L70B50



Operating Temperature

-10°C to + 45°C

APPLICATIONS

Signboards
Buildings & Monuments
Billboards
Shopboards
Factories & Assembly Lines
Security & Perimeter Lighting



TECHNICAL SPECIFICATION

Product Code	System Wattage (W)	Dimension LXWXH	THD	Colour Temp. (CCT)	Weight (kg)
PFLM17508*	50W	230X200X57	≤ 10%	5700K	2.0
PFLM19708	70W	230X200X57	≤ 10%	5700K	2.0

* 120D beam

Panasonic

LED
Bright & Energy Saving



BRIGHTER LIGHT
FOR EVERY SPACE



3 STAR
RATING

Panasonic LED Bulbs, Now with 105 Lumen/Watt



PHOTO-
BIOLOGICALLY
SAFE



HIGHER
LUMEN
EFFICACY

LED FLOOD LIGHT

FLANO PRO

90W

Flood light luminaire comprises of die cast aluminium housing with toughened glass and PC lens, cradle mounting.



High on Efficacy

Efficacy > 100lm/W



Robust Design

Innovative, aesthetic and robust design with toughened glass and PC lens for better light distribution.



Wide Operating Voltage / Rated Voltage

140-270V AC /
220-240V AC/50Hz



Safe & Reliable

High Surge Protection: 4kV+10kV
Power Factor >0.95



High Performance Electronic Driver

Potted driver for better thermal reliability,
easy maintenance



Higher Life

Life: 50,000 BH @ L70B50



Operating Temperature

-10°C to +45°C

APPLICATIONS

Signboards
Buildings & Monuments
Billboards
Shopboards
Factories & Assembly Lines
Security & Perimeter Lighting



TECHNICAL SPECIFICATION

Product Code	System Wattage (W)	Dimension LXWXH	THD	Colour Temp. (CCT)	Weight (kg)
PFLM18908	90W	285X210X61	≤ 10%	5700K	2.9

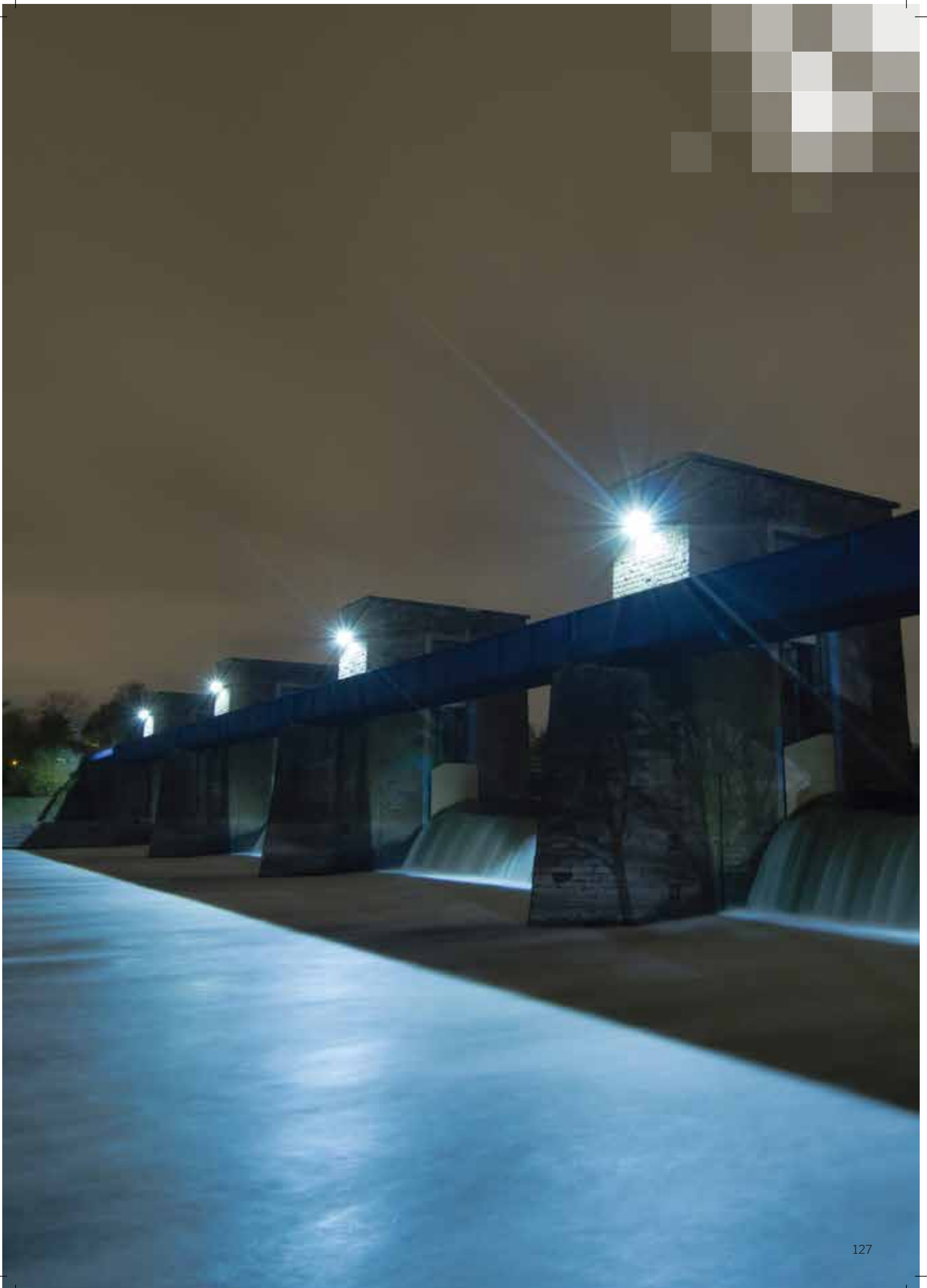

LED FLOOD LIGHT

FLANO PRO

150W/200W

Flood light luminaire comprises of die cast aluminium housing with frame, toughened glass with PC lens, cradle mounting.



High on Efficacy

Efficacy > 100lm/W



Robust Design

Innovative, aesthetic and robust design with frame, toughened glass and PC lens for better light distribution.



Wide Operating Voltage / Rated Voltage

140-270V AC /
220-240V AC/50Hz



Safe & Reliable

High Surge Protection: 4kV+10kV
Power Factor >0.95



High Performance Electronic Driver

Potted driver for better thermal reliability,
easy maintenance



Higher Life

Life: 50,000 BH @ L70B50



Operating Temperature

-10°C to + 45°C

APPLICATIONS

Signboards
Buildings & Monuments
Billboards
Shopboards
Factories & Assembly Lines
Security & Perimeter Lighting



TECHNICAL SPECIFICATION

Product Code	System Wattage (W)	Dimension LXWXH	THD	Colour Temp. (CCT)	Weight (kg)
PFLM18FG8	150W	350X285X85	≤ 10%	5700K	5.5
PFLM18MN8	200W	350X285X85	≤ 10%	5700K	5.5



LED FLOOD LIGHT

FLANO PRO

250W

Flood light luminaire comprises of die cast aluminium housing with toughened glass and PC lens, cradle mounting.



High on Efficacy
Efficacy > 100lm/W



Robust Design
Innovative, aesthetic and robust design with toughened glass and PC lens for better light distribution.



Wide Operating Voltage / Rated Voltage
140-270V AC /
220-240V AC/50Hz



Safe & Reliable
High Surge Protection: 4kV+10kV
Power Factor >0.95



High Performance Electronic Driver
Potted driver for better thermal reliability, easy maintenance



Higher Life
Life: 50,000 BH @ L70B50



Operating Temperature
-10°C to + 45°C

APPLICATIONS

Signboards
Buildings & Monuments
Billboards
Shopboards
Factories & Assembly Lines
Security & Perimeter Lighting



TECHNICAL SPECIFICATION

Product Code	System Wattage (W)	Dimension LXWXH	THD	Colour Temp. (CCT)	Weight (kg)
PFLM18RS8	250W	365X465X140	≤ 10%	5700K	8.5



LED FLOOD LIGHT

FLANO PRO

300W/350W/400W

Flood light luminaire comprises of die cast aluminium housing with frame, toughened glass and PC lens, cradle mounting.



High on Efficacy

Efficacy > 100lm/W



Robust Design

Innovative, aesthetic and robust design with frame, toughened glass and PC lens for better light distribution.



Wide Operating Voltage / Rated Voltage

140-270V AC /
220-240V AC/50Hz



Safe & Reliable

High Surge Protection: 4kV+10kV
Power Factor >0.95



High Performance Electronic Driver

Potted driver for better thermal reliability,
easy maintenance



Higher Life

Life: 50,000 BH @ L70B50



Operating Temperature

-10°C to +45°C

APPLICATIONS

Signboards
Buildings & Monuments
Billboards
Shopboards
Factories & Assembly Lines
Security & Perimeter Lighting



TECHNICAL SPECIFICATION

Product Code	System Wattage (W)	Dimension LXWXH	THD	Colour Temp. (CCT)	Weight (kg)
PFLM20WX8	300W	560X350X90	≤ 10%	5700K	10.3
PFLM20ZC8	350W	560X350X90	≤ 10%	5700K	10.3
PFLM20ZH8	400W	560X350X90	≤ 10%	5700K	10.3



LED FLOOD LIGHT

FLANO PRO

500W

Flood light luminaire comprises of die cast aluminium housing with toughened glass and PC lens, cradle mounting.



High on Efficacy

Efficacy > 100lm/W



Robust Design

Innovative, aesthetic and robust design with toughened glass and PC lens for better light distribution.



Wide Operating Voltage / Rated Voltage

140-270V AC /
220-240V AC/50Hz



Safe & Reliable

High Surge Protection: 4kV+10kV
Power Factor >0.95



High Performance Electronic Driver

Potted driver for better thermal reliability,
easy maintenance



Higher Life

Life: 50,000 BH @ L70B50



Operating Temperature

-10°C to +45°C

APPLICATIONS

Signboards
Buildings & Monuments
Billboards
Shopboards
Factories & Assembly Lines
Security & Perimeter Lighting



TECHNICAL SPECIFICATION

Product Code	System Wattage (W)	Dimension LXWXH	THD	Colour Temp. (CCT)	Weight (kg)
PFLM20ZS8	500W	720X420X140	≤ 10%	5700K	16.0



LANDSCAPE LIGHTING

CREATING MEANINGFUL LIGHTING
FOR OUTDOOR SPACE

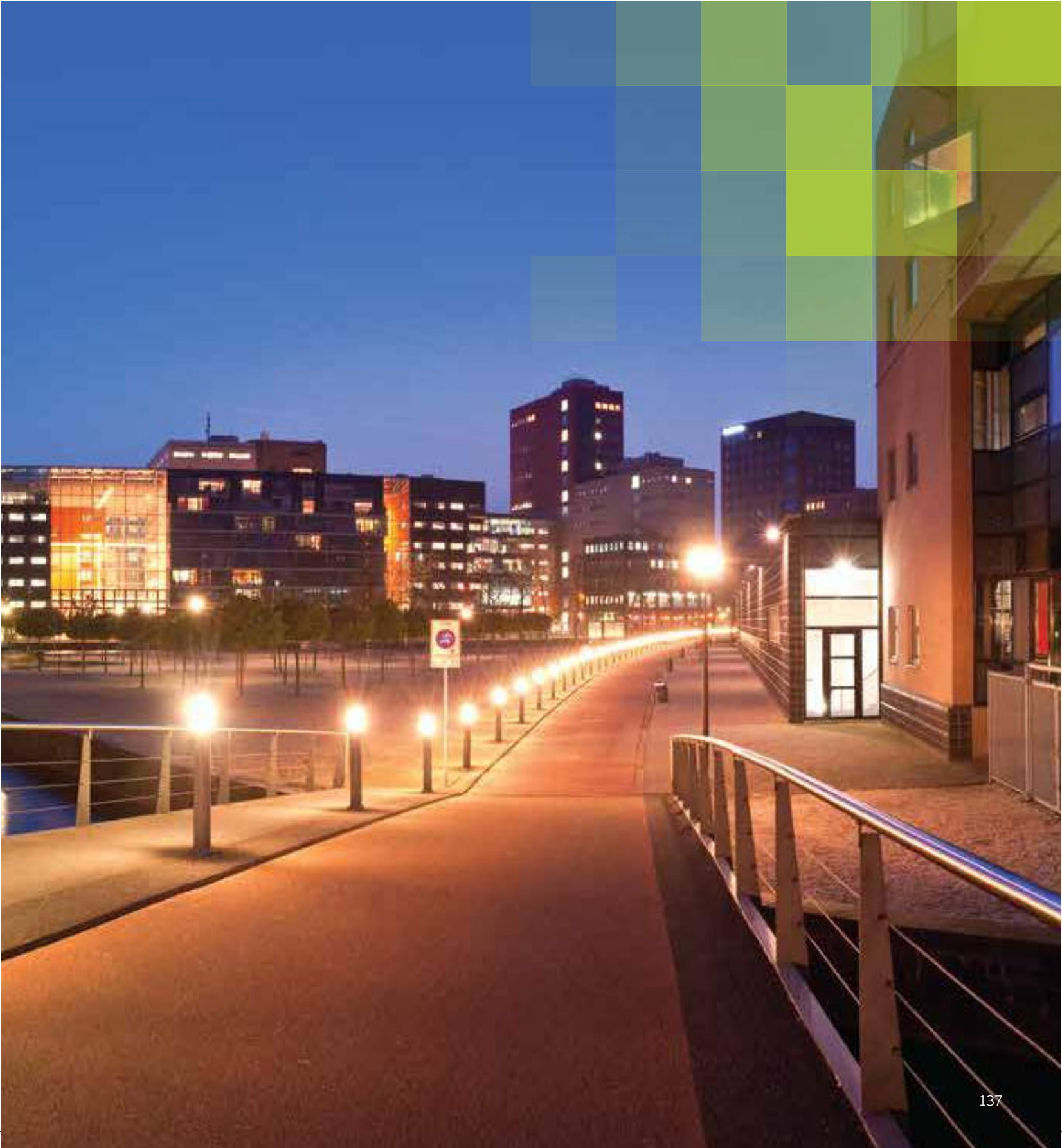

Panasonic





LANDSCAPE LIGHTING

The perfect lighting solution illuminates the outdoors aesthetically and completely with functional benefits. If you are looking to highlight certain aspects of your layout while ensuring smooth operations of the lights, choose our landscape lighting.

With our products, you have the right lighting to illuminate a private space of your own or public areas. Choose to up the aesthetics of a chosen area, up to safety and accessibility. Be it any event, brighten it up with Panasonic Post Top and Bollards.

POST TOP



When lighting an outdoor space, post-top lights are key. They work best when lit up in a pathway or gardens. While illuminating the space, ambient lighting that is uniform up visibility thereby improving safety.

BOLLARD



Low illumination close to the ground offered by bollard lighting help pedestrians sees better. Designed for precision, you have control over all lighting aspects, be it direction or colour. Easy installation and low maintenance are added benefits.



ILLUMINATE & BEAUTIFY

Light up paths and structures while not compromising on the aesthetics. Bring to attention every detail choosing from a variety of features, styles and finishes. Add drama, highlight key features of the space with the varied options available matching your aesthetic sense.

FUNCTIONALITY & EASE

The right lighting not just adds charm but also creates a space that is functional. It offers several options for you to create lighting effects that are unique. Think different colour temperatures and fixtures. All these with features that ensure ease of use and control.



UNCOMPROMISED SAFETY

Safety is paramount. While you add a never-before beautiful illuminated look to your spaces, be assured of safety. Adequate and essential lighting makes sure pathways, decks and other areas remain safe for use.

COMPLETE SECURITY

Be at ease with Panasonic Landscape Lighting when it comes with extra security at night. This perfect lighting can beautify the garden faintly, glow spots making for a well-lit space.



LED POST TOP

SANDO

40W

Aesthetically designed IP65 LED Post Top light luminaire comprises of spun aluminum top cover, die cast aluminum heat sink, frosted polycarbonate diffuser and die cast mounting base arm.



High on Efficacy

115 lm/W available in 5700K CCT



Robust Design

Powder coated Spun aluminum top cover with die cast mounting base



Wide Operating Voltage / Rated Voltage

140-270V AC /
220-240V AC/50Hz



Safe & Reliable

High Surge Protection: 4kV
External Surge Protection of 10kV



Weather Proof

IP65 Protection



Long Life

Specially designed heat sink for long life of 50,000 BH @ L70B50



Operating Temperature

-10°C to +45°C

APPLICATIONS

Garden

Parks

Shopping Complex

Malls

Walkways

Commercial Building Area
& Compounds



TECHNICAL SPECIFICATION

Product Code	System Wattage (W)	LxWxH (mm)	THD	Colour Temp. (CCT)
PPTM02408	40W	410x410x415	≤10	5700
PPTM02404	40W	410x410x415	≤10	4000

Pole Dia - Suitable upto 60mm OD



LED POST TOP

KINOKO

20W

Aesthetically designed IP65 LED Post Top light luminaire comprises of spun aluminum top cover, aluminum heat sink, frosted polycarbonate diffuser and die cast aluminum mounting base.



High on Efficacy

100 lm/W available in 5700K CCT



Robust Design

Powder coated spun aluminum top cover with die cast mounting base



Wide Operating Voltage / Rated Voltage

140-270V AC /
220-240V AC/50Hz



Safe & Reliable

High Surge Protection: 4kV



Weather Proof

IP65 Protection



Long Life

Specially designed heat sink for long life of 50,000 BH @ L70B50



Operating Temperature

-10°C to + 45°C

APPLICATIONS

Garden

Parks

Shopping Complex

Malls

Walkways

Commercial Building Area
& Compounds



TECHNICAL SPECIFICATION

Product Code	System Wattage (W)	LxWxH (mm)	THD	Colour Temp. (CCT)
PPTM02208	20W	330x330x405	≤10	5700
PPTM02204	20W	330x330x405	≤10	4000

Pole Dia - Suitable upto 60mm OD

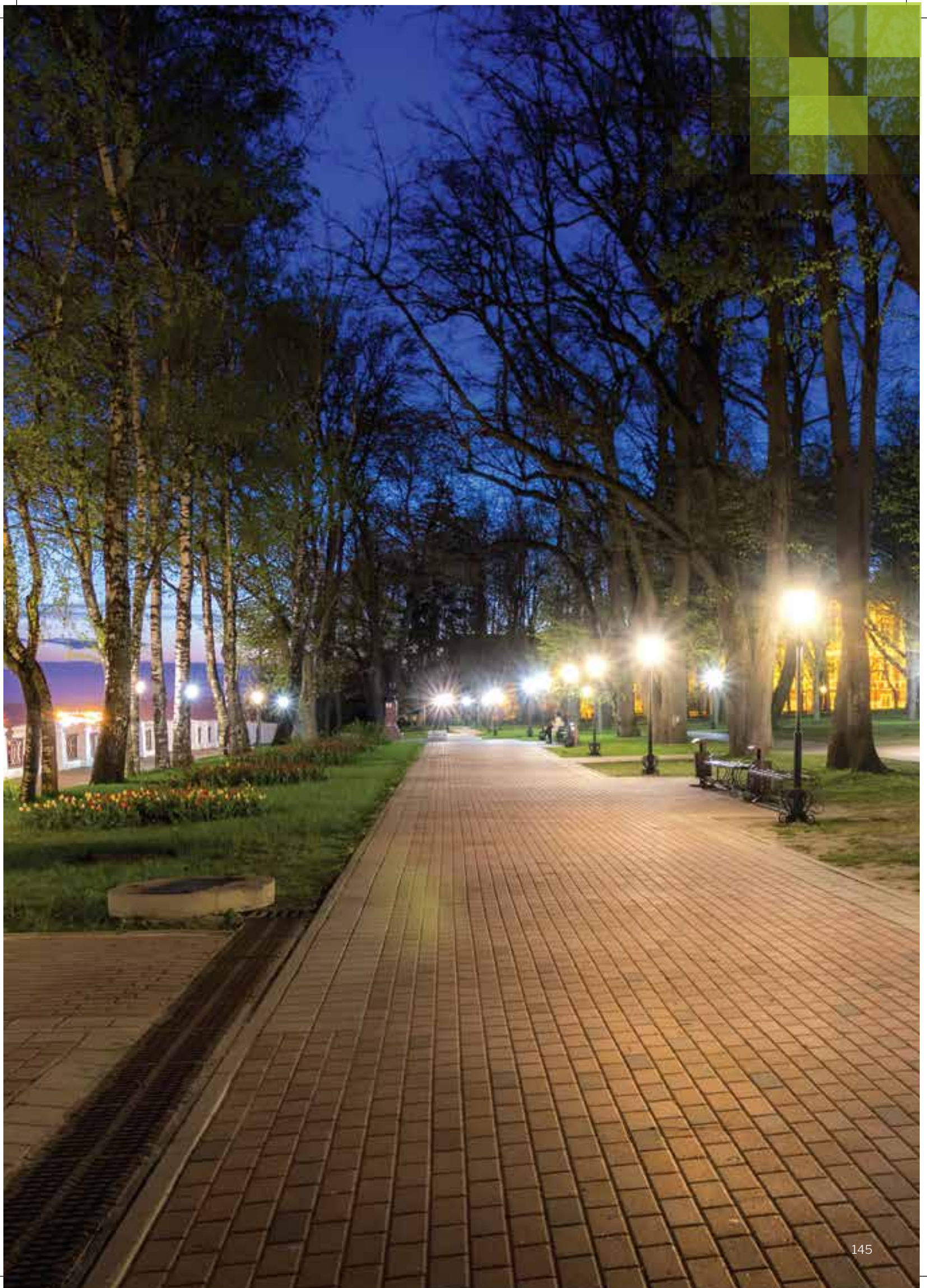

LED POST TOP

KYYNEL

60W/70W

Aesthetically designed IP65 LED Post Top light luminaire comprises of spun aluminium top cover, die cast aluminium heatsink, opal pmma acrylic diffuser and die cast mounting base arm.



High on Efficacy

110 lm/W@70W available in 5700K CCT
105 lm/W@60W available in 5700K CCT



Robust Design

Powder coated spun aluminum top cover with die cast mounting base



Wide Operating Voltage / Rated Voltage

140-270V AC /
220-240V AC/50Hz



Safe & Reliable

High Surge Protection: 4kV
External Surge Protection of 10kV



Weather Proof

IP65 Protection



Long Life

Specially designed heat sink for long life of 50,000 BH @ L70B50



Operating Temperature

-10°C to + 45°C

APPLICATIONS

Garden

Parks

Shopping Complex

Malls

Walkways

Commercial Building Area
& Compounds



TECHNICAL SPECIFICATION

Product Code	System Wattage (W)	LxWxH (mm)	THD	Colour Temp. (CCT)
PPTM02604	60W	450x450x660	≤10	4000
PPTM02608	60W	450x450x660	≤10	5700
PPTM02704	70W	450x450x660	≤10	4000
PPTM02708	70W	450x450x660	≤10	5700

Pole Dia - Suitable upto minimum 40mm OD & maximum 60mm OD



LED POST TOP

FANAL

40W/60W

Aesthetically designed IP65 LED Post Top light luminaire comprises of spun aluminium top cover, die cast aluminium heatsink, opal polycarbonate diffuser and die cast mounting base arm.



High on Efficacy

90 lm/W available in 5700K CCT



Robust Design

Powder coated spun aluminum top cover with die cast mounting base



Wide Operating Voltage / Rated Voltage

140-270V AC /
220-240V AC/50Hz



Safe & Reliable

High Surge Protection: 4kV
External Surge Protection of 10kV



Weather Proof

IP65 Protection



Long Life

Specially designed heat sink for long life of 50,000 BH @ L70B50



Operating Temperature

-10°C to + 45°C

APPLICATIONS

Garden

Parks

Shopping Complex

Malls

Walkways

Commercial Building Area
& Compounds



TECHNICAL SPECIFICATION

Product Code	System Wattage (W)	LxWxH (mm)	THD	Colour Temp. (CCT)
PPTM03404	40W	410x410x545	≤10	4000
PPTM03408	40W	410x410x545	≤10	5700
PPTM03604	60W	410x410x545	≤10	4000
PPTM03608	60W	410x410x545	≤10	5700

Pole Dia - Suitable upto min 40mm OD & max 60mm OD



LED BOLLARD

BORADO

10W

Aesthetically designed IP65 LED Bollard luminaire comprises of galvanised extruded mild steel pipe housing with opal polycarbonate diffuser and aluminum mounting base.



High on Efficacy

90 lm/W available in 5700K CCT



Robust Design

Perfect Light Distribution



Wide Operating Voltage / Rated Voltage

140-270V AC /
220-240V AC/50Hz



Safe & Reliable

High Surge Protection: 4kV
Power Factor >0.95



Weather Proof

IP65 Protection



Long Life

Specially designed heat sink for
long life of 50,000 BH @ L70B50



Operating Temperature

-10°C to + 45°C

APPLICATIONS

Illuminating pathways

Gardens

Commercial Complex

Hotels

Malls



TECHNICAL SPECIFICATION

Product Code	System Wattage (W)	LxWxH (mm)	THD	Colour Temp. (CCT)
PBDM03104	10W	180x105x1000	≤10	4000
PBDM03108	10W	180x105x1000	≤10	5700

Pole Dia - Suitable upto 60mm OD

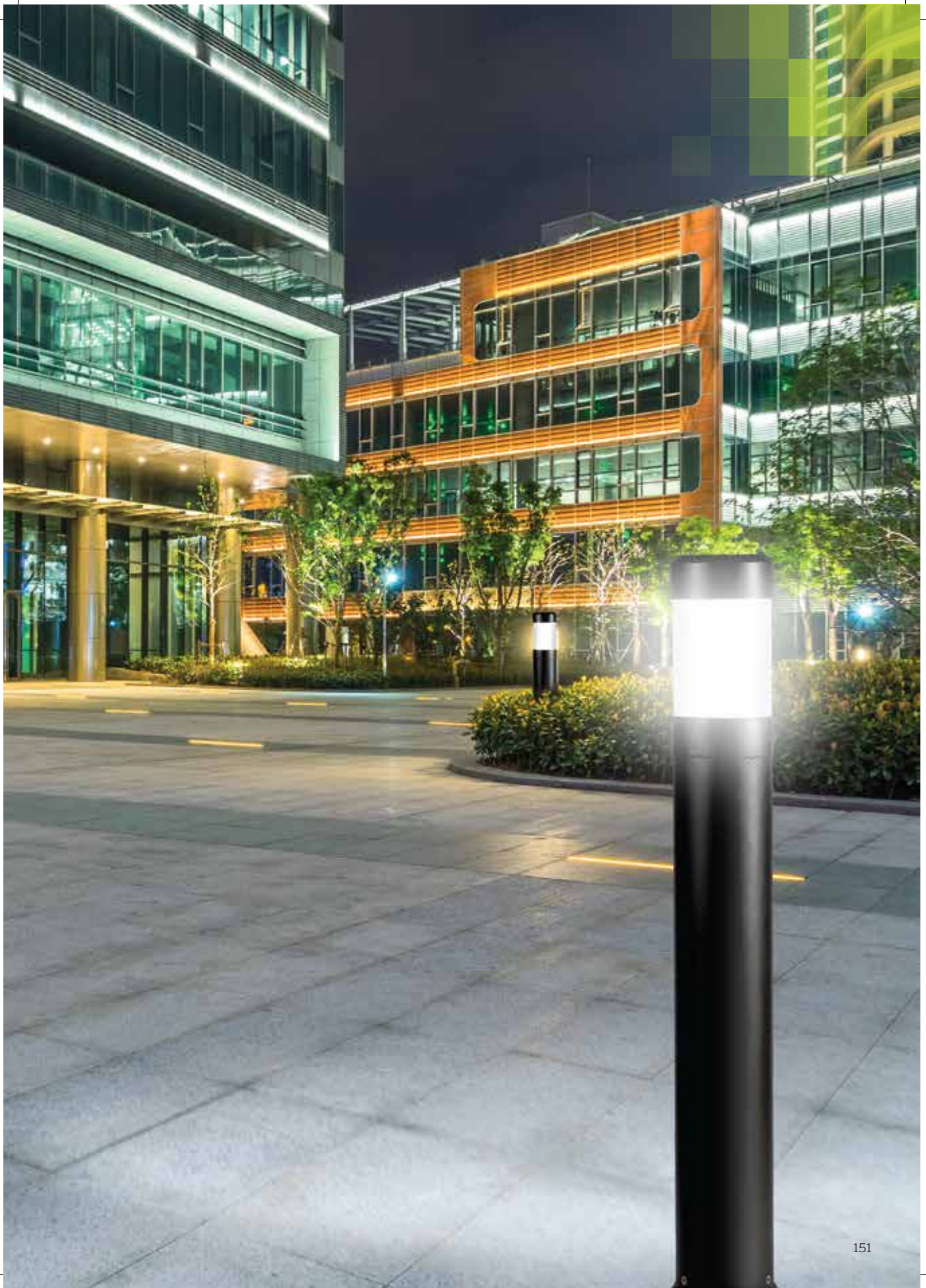

OUR PRESTIGIOUS PROJECTS

INDOOR COMMERCIAL



ACC Office



Hexaware Office



Mahindra Showroom



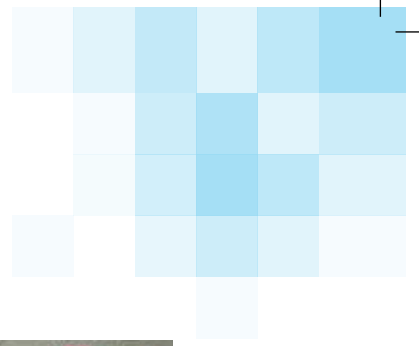

Art Gallery



Naruvi Hospital

INDUSTRIAL LIGHTING



BMW Warehouse



Deccan Chemical





Ambica Polymer



TVS Warehouse



Indore Airport



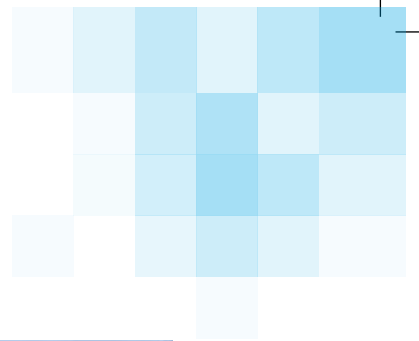

STREET LIGHTING



Bathinda



Balasinor City



Nandigama NHAI



SG Highway, Ahmedabad

LANDSCAPE LIGHTING



Indore Dewas NHAI



Biswa Bangla Gate, Kolkata

Phase out product list

These products are available only till the stock last, successors shall be launched.

Product Code	System Wattage (W)	DiaxH (mm)	Cutout (mm)	THD	Colour Temp. (CCT)
SPUR					
PDLM12053	5W	120x30	Ø102	≤ 20%	3000K
PDLM12054	5W	120x30	Ø102	≤ 20%	4000K
PDLM12057	5W	120x30	Ø102	≤ 20%	6500K
PDLM12103	10W	150x30	Ø128	≤ 20%	3000K
PDLM12104	10W	150x30	Ø128	≤ 20%	4000K
PDLM12107	10W	150x30	Ø128	≤ 20%	6500K
PDLM12153	15W	198x30	Ø178	≤ 20%	3000K
PDLM12154	15W	198x30	Ø178	≤ 20%	4000K
PDLM12157	15W	198x30	Ø178	≤ 20%	6500K
PDLM12203	20W	198x30	Ø178	≤ 20%	3000K
PDLM12204	20W	198x30	Ø178	≤ 20%	4000K
PDLM12207	20W	198x30	Ø178	≤ 20%	6500K
CAMBER MODAN					
PDLM10103BS	10W	120x35	—	≤ 20%	3000K
PDLM10104BS	10W	120x35	—	≤ 20%	4000K
PDLM10106BS	10W	120x35	—	≤ 20%	6000K
PDLM10153BS	15W	170x35	—	≤ 20%	3000K
PDLM10154BS	15W	170x35	—	≤ 20%	4000K
PDLM10156BS	15W	170x35	—	≤ 20%	6000K
PDLM10203BS	20W	225x35	—	≤ 20%	3000K
PDLM10204BS	20W	225x35	—	≤ 20%	4000K
PDLM10206BS	20W	225x35	—	≤ 20%	6000K
PDLM11103BS	10W	120x120x35	—	≤ 20%	3000K
PDLM11104BS	10W	120x120x35	—	≤ 20%	4000K
PDLM11106BS	10W	120xx120x35	—	≤ 20%	6000K
PDLM11153BS	15W	170x170x35	—	≤ 20%	3000K
PDLM11154BS	15W	170x170x35	—	≤ 20%	4000K
PDLM11156BS	15W	170x170x35	—	≤ 20%	6000K
PDLM11203BS	20W	225x225x35	—	≤ 20%	3000K
PDLM11204BS	20W	225x225x35	—	≤ 20%	4000K
PDLM11206BS	20W	225x225x35	—	≤ 20%	6000K
HARROW AL					
PBTM08204	20W	1185x20x32	—	≤ 25%	4000K
PBTM08208	20W	1185x20x32	—	≤ 25%	5700K
PBTM08364	36W	1175x30x36	—	≤ 15%	4000K
PBTM08368	36W	1175x30x36	—	≤ 15%	5700K

HEAD / REGIONAL OFFICES

WEST (H.O.)

Panasonic Life Solutions India Pvt. Ltd.
3rd Floor, B Wing, I-Think
Techno Campus, Pokhran Road No. 2,
Thane (W), Thane - 400 607
Maharashtra Tel: 022 42228888

EAST

Panasonic Life Solutions India Pvt. Ltd.
P.S. Srijan Corporate Park", Tower 1,
Unit No. 604, 6th Floor,
Block - GP2, Sector V,
Salt Lake, Bidhannagar,
Kolkata- 700 091

SOUTH

Panasonic Life Solutions India Pvt. Ltd.
123/124, Level 3,
Isphani Centre,
Nungambakkam High Road,
Chennai 600 034

NORTH

Panasonic Life Solutions India Pvt. Ltd.
Plot No-7, 6th Floor, TDI Center Jasola,
Near Jasola Metro Station,
Mathura Road,
New Delhi -110025

Panasonic

Panasonic Life Solutions India Pvt. Ltd.

3rd Floor, B wing, I-Think Techno Campus, Pokharan Road No 2,
Thane (West), Thane - 400607, Maharashtra.

Customer Care No.: 022 4130 4130

Email: wecare@in.panasonic.com